

INDEX

SHEET NO.	SUBJECT
1	Curb Ramp Drawing Index and General Notes
2-3	Perpendicular Curb Ramp Typical Placement
4	Perpendicular Curb Ramp Component Details
5	One-Way-Directional Perpendicular Curb Ramp Typical Placement
6	One-Way-Directional Perpendicular Curb Ramp Component Details
7	Parallel Curb Ramps Typical Placement
8	Parallel Curb Ramp Component Details
9	Blended Transition Curb Ramp, Depressed Curb Ramp and Diagonal Curb Ramp Typical Placement
10	Blended Transition Curb Ramp Component Details
11	Median Cut-Through and Median Perpendicular Curb Ramp Typical Placement
12-13	Detectable Warning Surface Placement and Configuration
14	Detectable Warning Surface Details

GENERAL NOTES:

- All slopes are absolute rather than relative to the sidewalk or roadway grade. Slopes at least 0.50% less than the maximum are preferred.
- Ramp or Blended Transition. A ramp or blended transition shall be used to lower or raise the sidewalk to connect with the street or highway.
- Turning Space. A turning space shall be provided at the top of a perpendicular ramp, bottom of a parallel ramp, or where the pedestrian travel requires a change in direction. A common turning space may be shared by adjacent ramps. The turning space shall have a minimum clear dimension of 4 ft x 4 ft. Where the turning space is constrained at the back of the sidewalk by a curb, retaining wall, building, or feature over 2 inches in height, the minimum clear dimension shall be 4 ft x 5 ft, with the 5-ft dimension in the direction of the ramp running slope.
- Flared Side. A flared side shall be used adjacent to a walkable surface. A flared side may be used adjacent to a non-walkable surface. A flared side shall have a maximum slope of 10.00% measured parallel to the back of the curb.
- Return Curb. A return curb is placed perpendicular to the roadway curb. A return curb may be used adjacent to a non-walkable surface. A return curb shall not be used adjacent to a walkable surface. The return curb may be omitted where the non-walkable surface is flared and the curb adjacent the roadway is tapered to meet the flush curb at the bottom of the ramp.
- Clear Space. A clear space shall be provided beyond the bottom grade break of a curb ramp wholly contained within the crosswalk and wholly outside the parallel vehicular travel path. The clear space shall have a minimum clear dimension of 4 ft x 4 ft.
- Detectable Warning Surface. A detectable warning surface shall consist of truncated domes and be placed at each street, highway, or railroad crossing. The detectable warning surface shall extend a minimum of 2 ft in the direction of pedestrian travel and be placed the entire width of a ramp, blended transition, or turning space.
- Running Slope. The running slope of a ramp, blended transition, or turning space shall be measured parallel to the direction of pedestrian travel.
 - A running slope of 2.00% or less is considered level.
 - A ramp shall have a maximum running slope of 8.33% but shall not require a ramp length to exceed 15 ft.
 - A blended transition shall have a maximum running slope of 5.00%.
 - A turning space shall have a maximum running slope of 2.00%.
- Width. Unless otherwise noted, minimum width of a ramp, blended transition, or turning space, excluding flared sides or return curb, shall be 4 ft.
- Grade Break. A grade break at the top and bottom of a ramp, blended transition, or turning space shall be perpendicular to the running slope. Grade breaks shall not be within the ramp, blended transition, turning space, or detectable warning surface. Grade breaks shall be flush. Vertical discontinuities shall not be greater than 1/2 in. Where a discontinuity is greater than 1/4 in. the surface shall be beveled with a slope not steeper than 1V:2H.
- Cross Slope Exceptions. The cross slope of a ramp, blended transition, or turning space shall be measured perpendicular to the direction of pedestrian travel.
 - The maximum cross slope at a pedestrian street crossing without posted yield or stop control shall be 5.00%.
 - The maximum cross slope at a pedestrian street crossing with posted yield or stop control shall be 2.00%.
 - The maximum cross slope at a midblock crossing shall be the established grade of the adjacent roadway.
- Counter Slope. A counter slope is the cross slope of the gutter or street adjacent the running slope of the ramp, blended transition, or turning space. See Standard Drawing E 604-SWCR-14 for counter slope details.
- Objects such as a utility cover, vault frame, and grating shall be placed outside the curb ramp.
- Curb ramps shall be placed within the marked crosswalk area.
- Drainage inlets should be located uphill from a curb ramp to prevent ponding in the path of pedestrian travel.

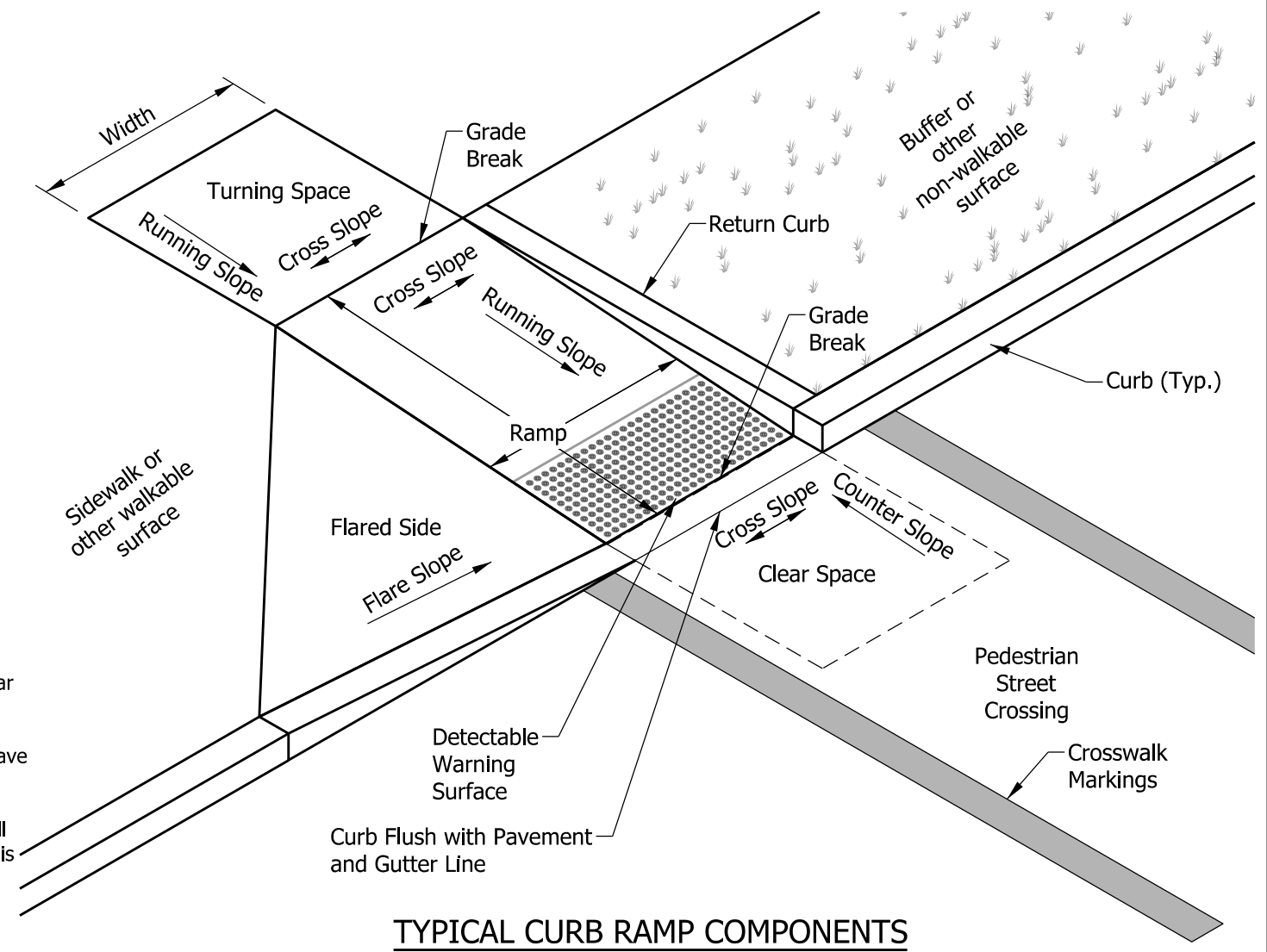

TYPICAL CURB RAMP COMPONENTS

INDIANA DEPARTMENT OF TRANSPORTATION

CURB RAMP DRAWING INDEX AND GENERAL NOTES

SEPTEMBER 2018

STANDARD DRAWING NO. E 604-SWCR-01

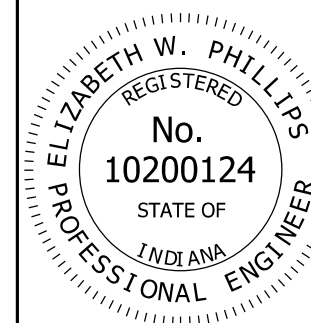

/s/ Elizabeth W. Phillips 03/20/18
DESIGN STANDARDS ENGINEER DATE

/s/ John Leckie 04/25/18
CHIEF ENGINEER DATE

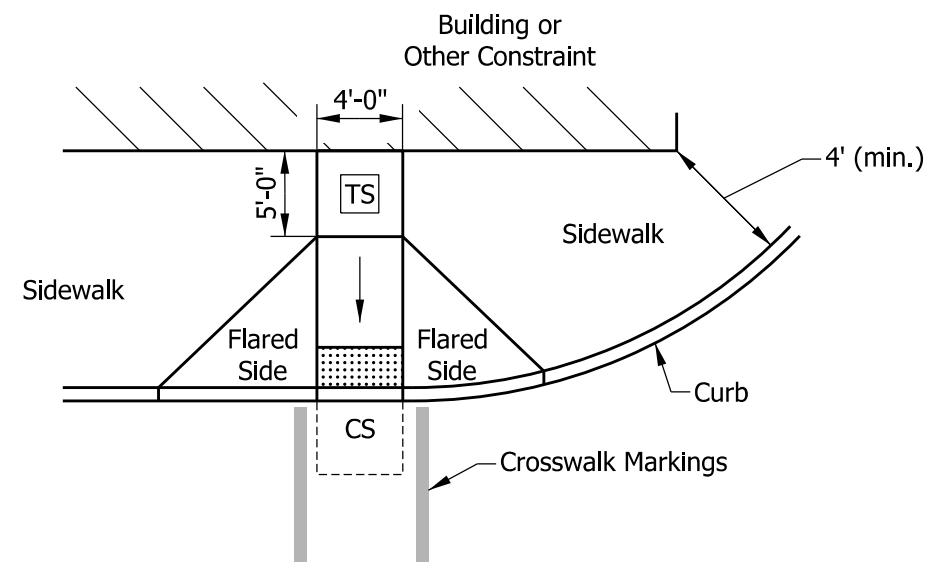

**PERPENDICULAR CURB RAMP
ADJACENT WALKABLE SURFACE**

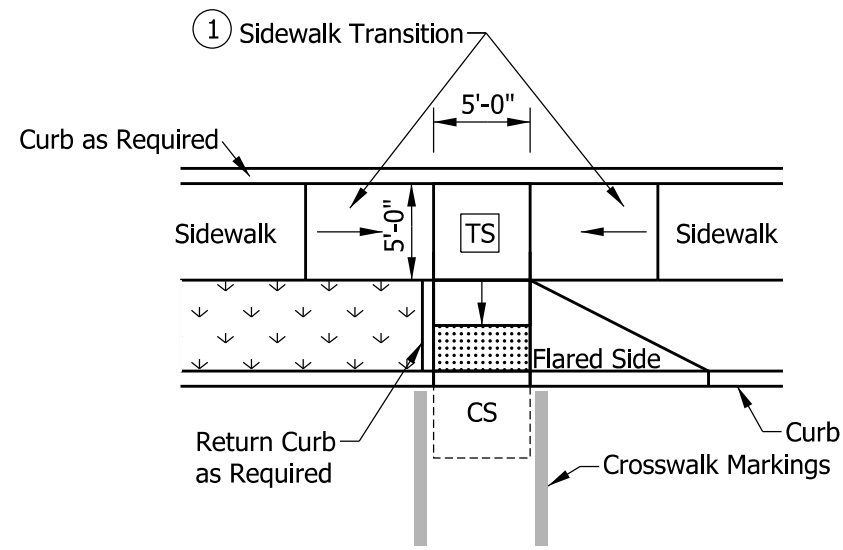

TIERED PERPENDICULAR CURB RAMP

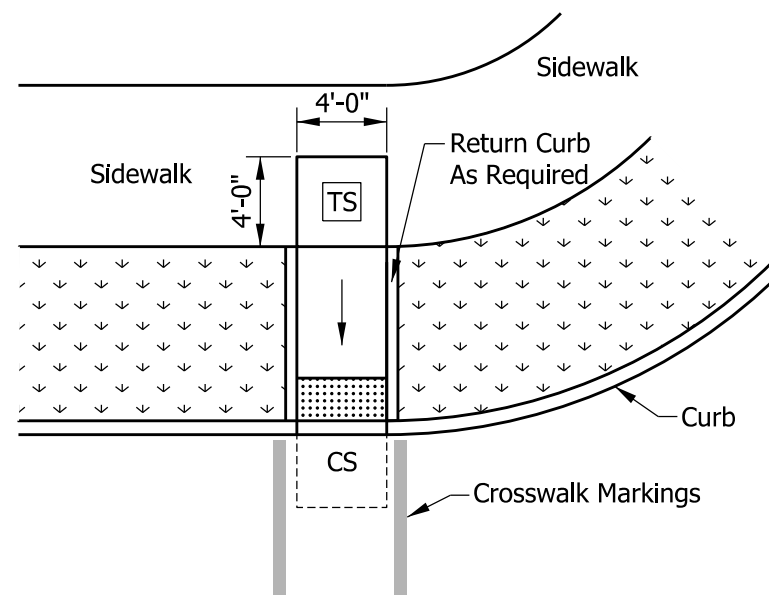

**PERPENDICULAR CURB RAMP
ADJACENT NON-WALKABLE SURFACE**

NOTES:

- ① Where insufficient width between the curb and back of sidewalk prevent a standard perpendicular curb ramp running slope, a sidewalk transition may be used to lower the sidewalk grade. The sidewalk transition running slope shall not exceed 8.33%. See Standard Drawing Series E 604-SDWK for sidewalk details.
2. The turning space shall have a minimum clear dimension of 4 ft x 4 ft and a running slope of 2.00% maximum. Where the turning space is constrained at the back of the sidewalk, the minimum clear dimension shall be 4 ft x 5 ft, with the 5-ft dimension in the direction of the ramp running slope.

LEGEND:

- Buffer or Other Non-Walkable Surface
- Ramp
- Detectable Warning Surface
- Turning Space
- Clear Space

INDIANA DEPARTMENT OF TRANSPORTATION

PERPENDICULAR CURB RAMP
TYPICAL PLACEMENT

SEPTEMBER 2018

STANDARD DRAWING NO. E 604-SWCR-02

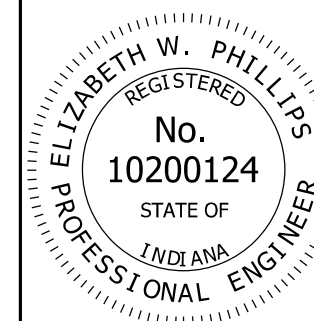

/s/ Elizabeth W. Phillips 03/29/18
DESIGN STANDARDS ENGINEER DATE

/s/ John Leckie 04/25/18
CHIEF ENGINEER DATE

NOTE:

1. The turning space shall have a minimum clear dimension of 4 ft x 4 ft and a running slope of 2.00% maximum. Where the turning space is constrained at the back of the sidewalk, the minimum clear dimension shall be 4 ft x 5 ft, with the 5-ft dimension in the direction of the ramp running slope.

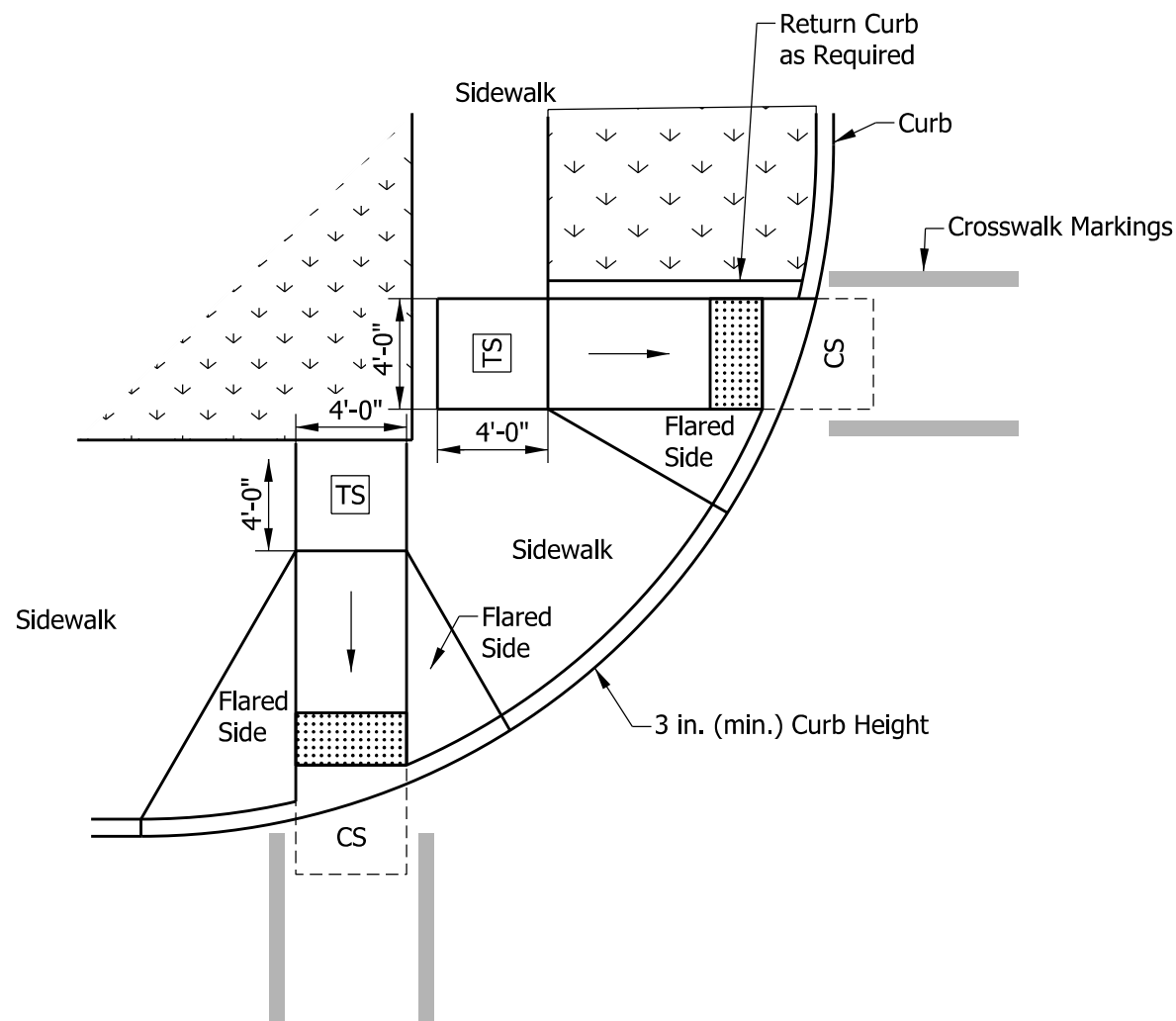



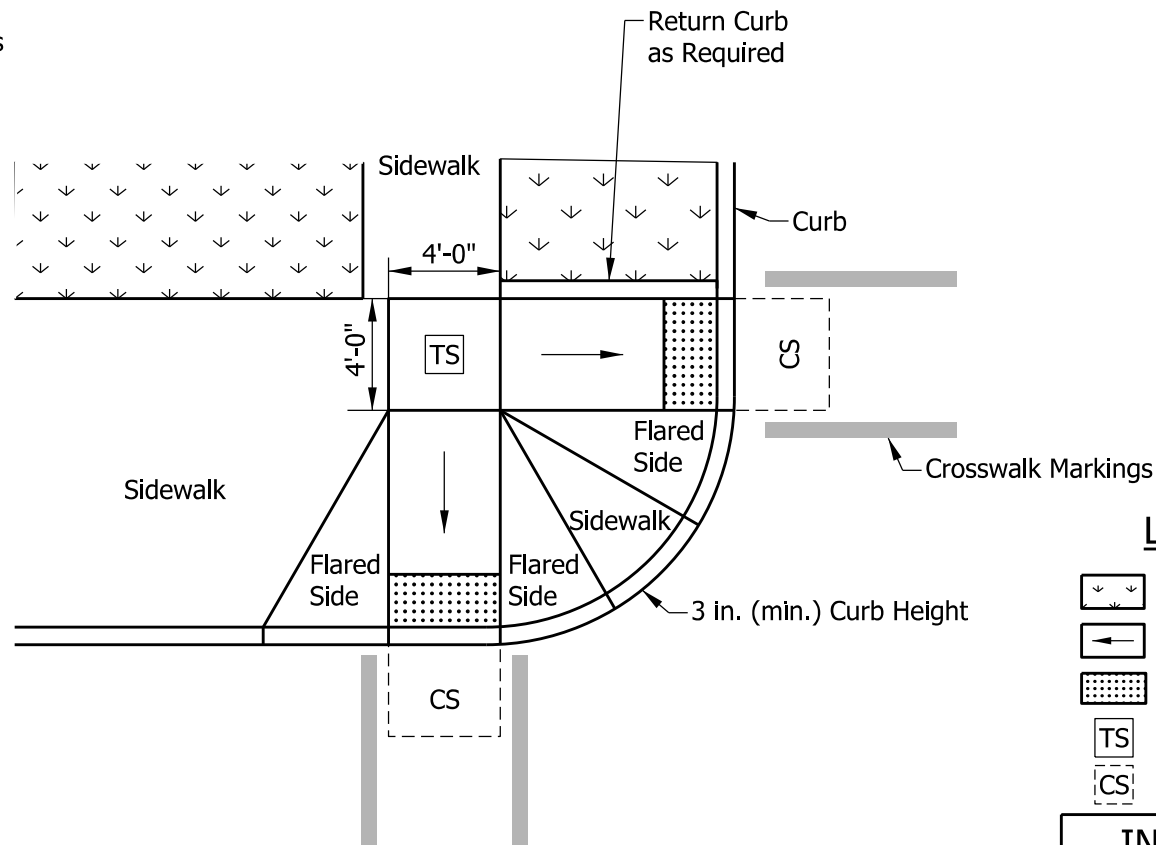

PAIRED PERPENDICULAR CURB RAMPS AT LARGE RADIUS



PAIRED PERPENDICULAR CURB RAMPS AT SMALL RADIUS

LEGEND:

-  Buffer or Other Non-Walkable Surface
-  Ramp
-  Detectable Warning Surface
-  Turning Space
-  Clear Space

INDIANA DEPARTMENT OF TRANSPORTATION

PAIRED PERPENDICULAR CURB RAMPS
TYPICAL PLACEMENT

SEPTEMBER 2016

STANDARD DRAWING NO. E 604-SWCR-03

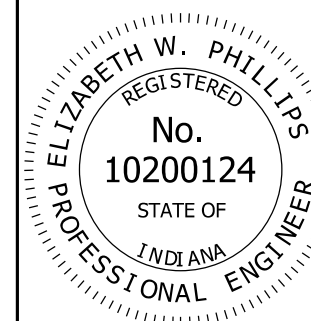

/s/ Elizabeth W. Phillips 03/15/16
DESIGN STANDARDS ENGINEER DATE

/s/ Mark A. Miller 03/18/16
CHIEF ENGINEER DATE

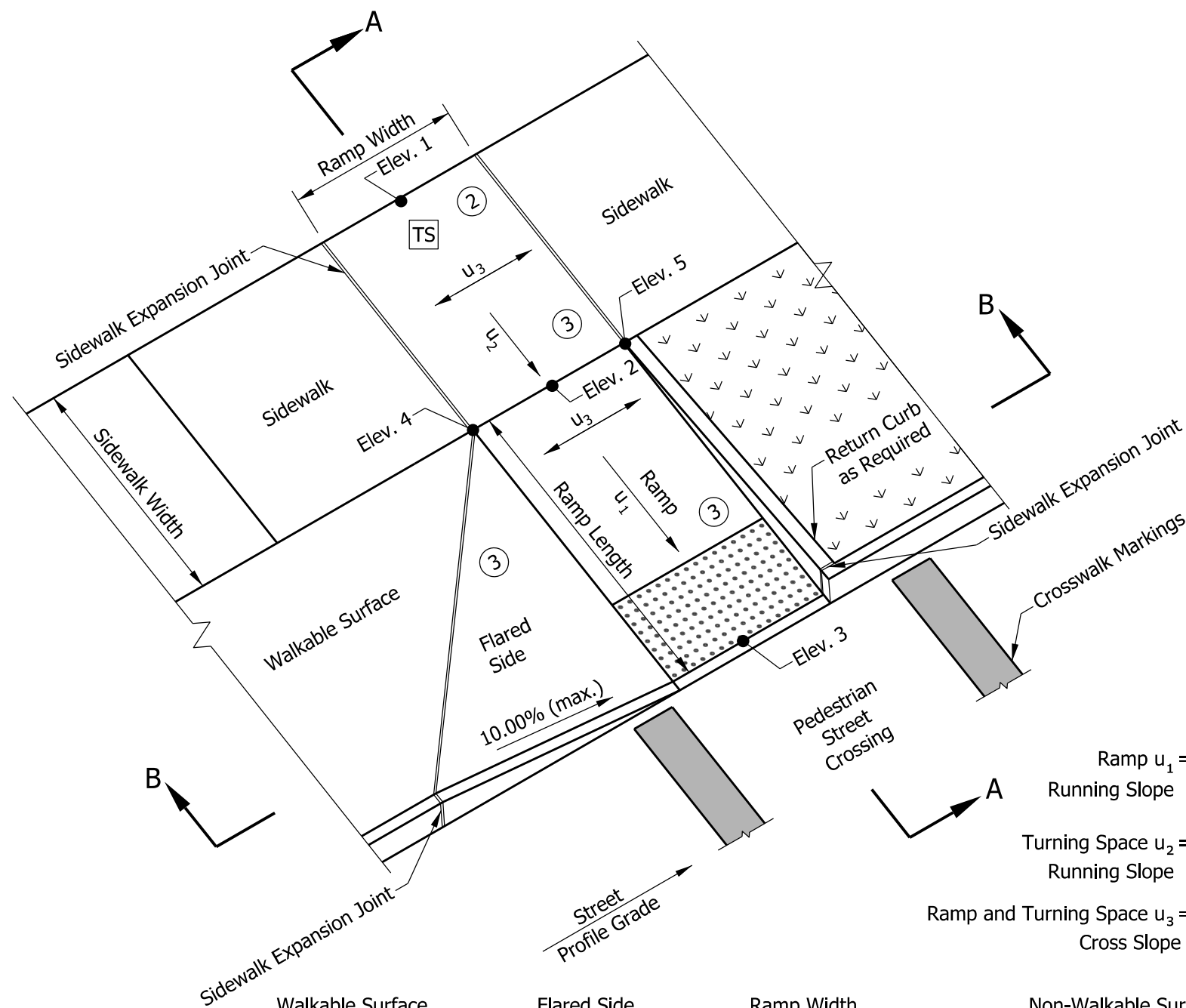

Component Slope Equations:

$$\text{Ramp } u_1 = \frac{\text{Elev. 2} - \text{Elev. 3}}{\text{Ramp Length}} \leq 8.33\%$$

$$\text{Turning Space } u_2 = \frac{\text{Elev. 1} - \text{Elev. 2}}{\text{Sidewalk Width}} \leq 2.00\%$$

$$\text{Ramp and Turning Space } u_3 = \frac{\text{Elev. 4} - \text{Elev. 5}}{\text{Ramp or Turning Space Width}} \leq 2.00\% \text{ (4)}$$

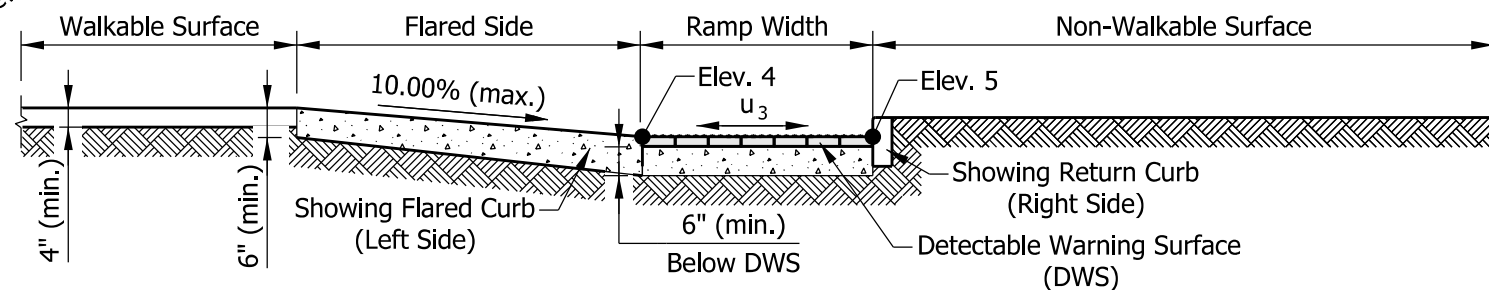

SECTION B-B

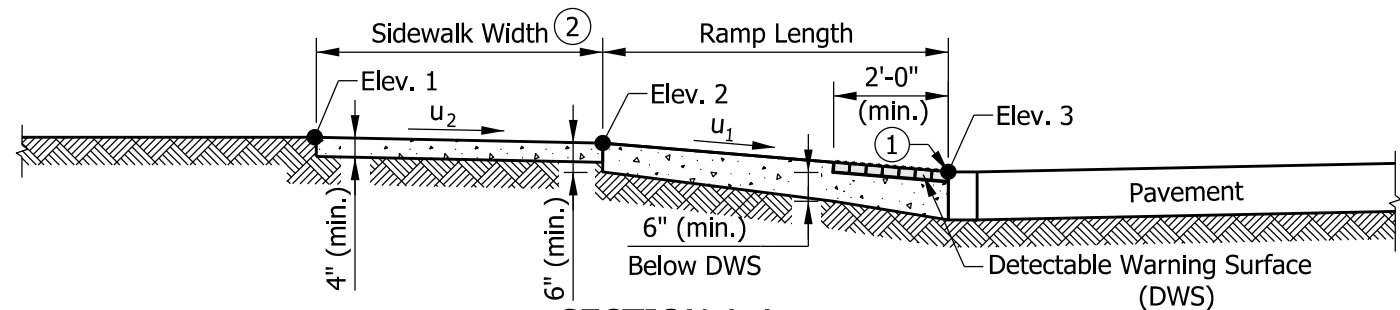

SECTION A-A

NOTES:

- ① The bottom edge of the ramp and top of curb shall be flush with the edge of adjacent pavement and gutter line.
- ② The turning space shall have a minimum clear dimension of 4 ft x 4 ft. Where the turning space is constrained at the back of the sidewalk, the minimum clear dimension shall be 4 ft x 5 ft, with the 5-ft dimension in the direction of the ramp running slope. Where a tiered perpendicular curb ramp is used, a constrained turning space shall have a minimum clear dimension of 5 ft x 5 ft.
- ③ Curb ramp surface shall be coarse broomed transverse to the running slope.
- ④ See Standard Drawing E 604-SWCR-01 for cross slope exceptions.
5. See Standard Drawing E 604-SWCR-12, -13, and -14 for Detectable Warning Surface placement, configuration, and details.
6. See Standard Drawing E 604-CCSJ-01 for sidewalk expansion joint details.

LEGEND:

- Buffer or Other Non-Walkable Surface
- Ramp
- Detectable Warning Surface
- Turning Space

INDIANA DEPARTMENT OF TRANSPORTATION

PERPENDICULAR CURB RAMP
COMPONENT DETAILS

SEPTEMBER 2018

STANDARD DRAWING NO. E 604-SWCR-04

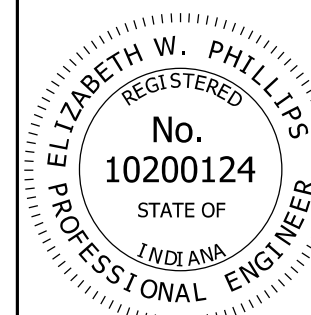

/s/ Elizabeth W. Phillips 03/29/18
DESIGN STANDARDS ENGINEER DATE

/s/ John Leckie 04/25/18
CHIEF ENGINEER DATE

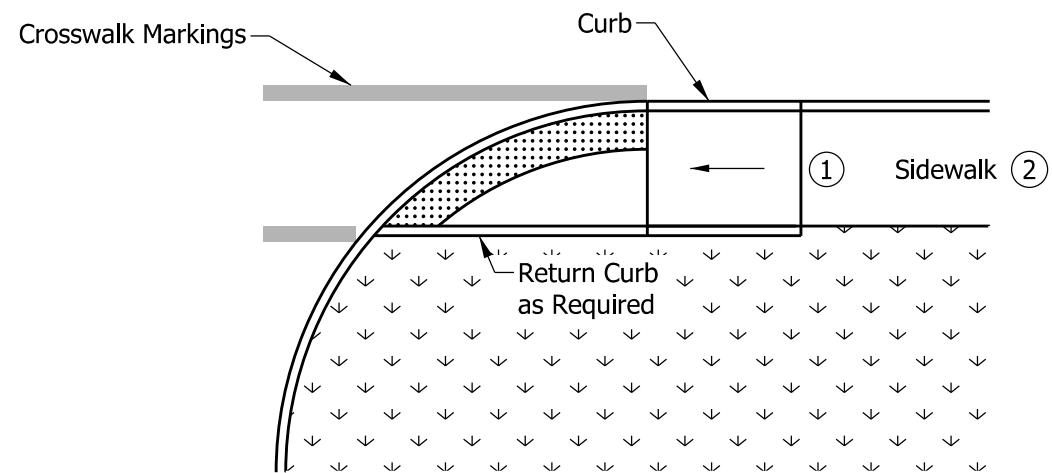

ONE-WAY DIRECTIONAL PERPENDICULAR CURB RAMP ADJACENT CURB

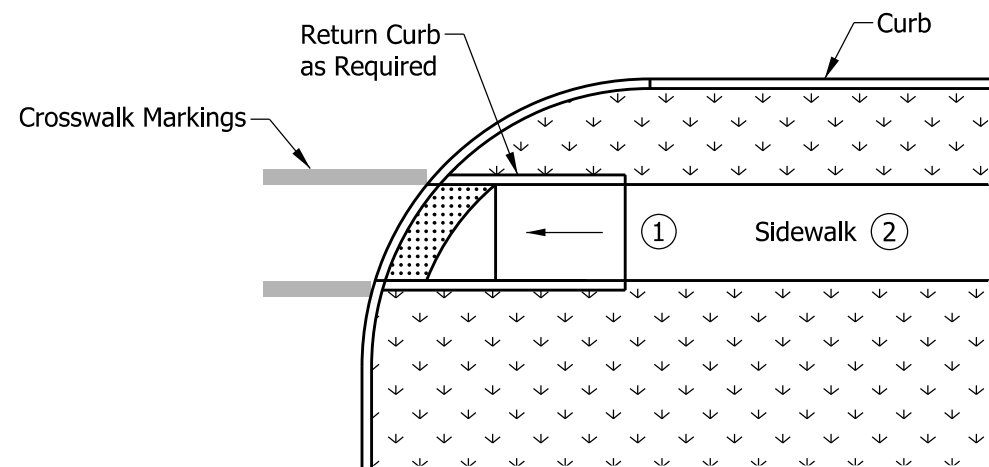

ONE-WAY DIRECTIONAL PERPENDICULAR CURB RAMP WITH BUFFER

NOTES:

- ① A turning space is not required at the top of the ramp for a one-way directional perpendicular curb ramp.
- ② Where there is no buffer between the sidewalk and curb the preferred minimum sidewalk width is 6 ft. Where a buffer is placed between the sidewalk and curb, the preferred minimum sidewalk width is 5 ft. See Standard Drawing Series E 604-SDWK for sidewalk details.

LEGEND:

- Buffer or Other Non-Walkable Surface
- Ramp
- Detectable Warning Surface

INDIANA DEPARTMENT OF TRANSPORTATION									
<p>ONE-WAY DIRECTIONAL PERPENDICULAR CURB RAMP TYPICAL PLACEMENT SEPTEMBER 2016</p>									
STANDARD DRAWING NO. E 604-SWCR-05									
	<table style="width: 100%; border-collapse: collapse;"> <tr> <td style="border-bottom: 1px solid black; padding: 2px;">/s/ <i>Elizabeth W. Phillips</i></td> <td style="border-bottom: 1px solid black; padding: 2px; text-align: right;">03/15/16</td> </tr> <tr> <td style="padding: 2px;">DESIGN STANDARDS ENGINEER</td> <td style="padding: 2px; text-align: right;">DATE</td> </tr> <tr> <td style="border-bottom: 1px solid black; padding: 2px;">/s/ <i>Mark A. Miller</i></td> <td style="border-bottom: 1px solid black; padding: 2px; text-align: right;">03/18/16</td> </tr> <tr> <td style="padding: 2px;">CHIEF ENGINEER</td> <td style="padding: 2px; text-align: right;">DATE</td> </tr> </table>	/s/ <i>Elizabeth W. Phillips</i>	03/15/16	DESIGN STANDARDS ENGINEER	DATE	/s/ <i>Mark A. Miller</i>	03/18/16	CHIEF ENGINEER	DATE
/s/ <i>Elizabeth W. Phillips</i>	03/15/16								
DESIGN STANDARDS ENGINEER	DATE								
/s/ <i>Mark A. Miller</i>	03/18/16								
CHIEF ENGINEER	DATE								

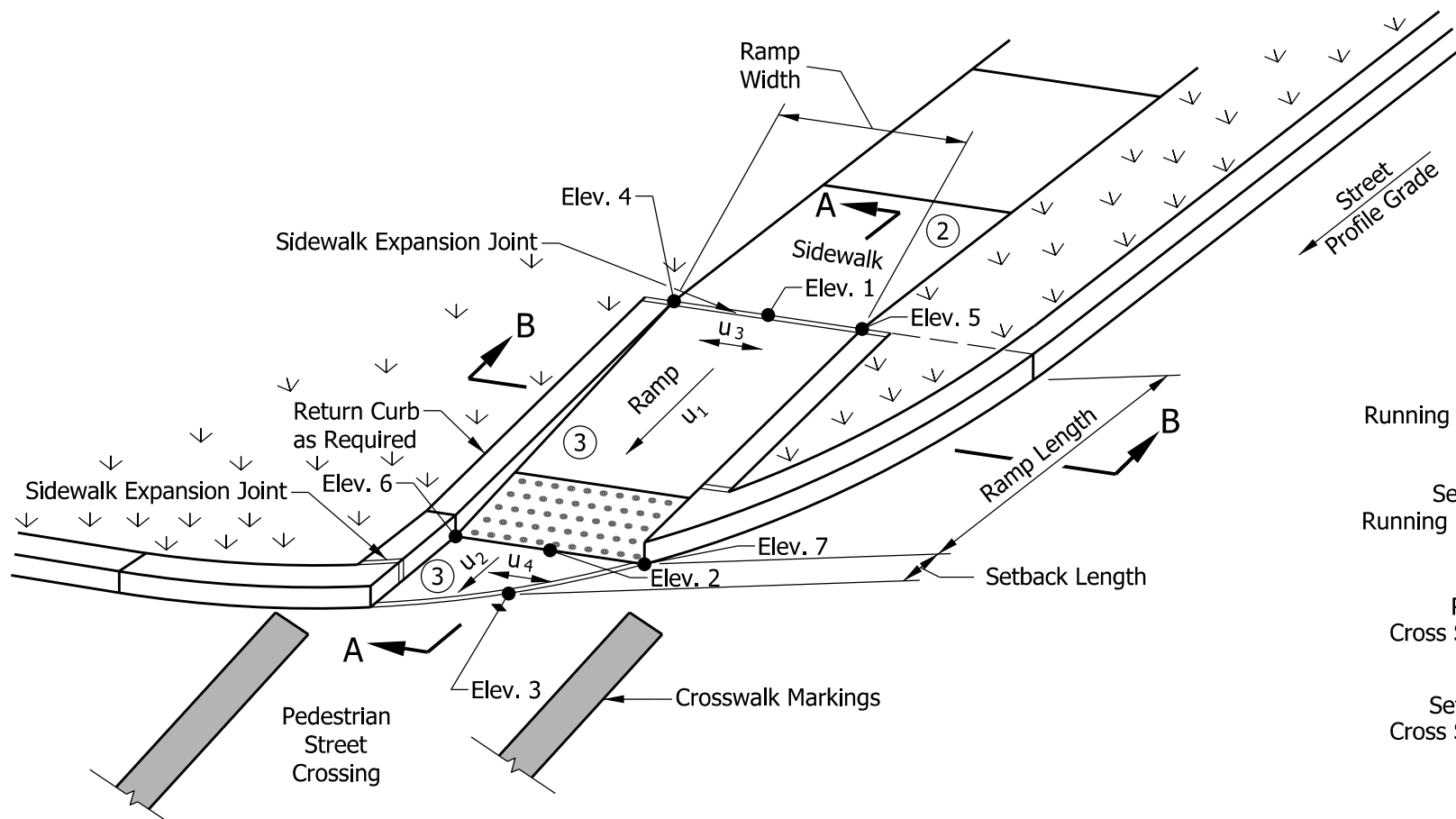

Component Slope Equations:

$$\text{Ramp Running Slope } u_1 = \frac{|\text{Elev. 1} - \text{Elev. 2}|}{\text{Ramp Length}} \leq 8.33\%$$

$$\text{Setback Running Slope } u_2 = \frac{|\text{Elev. 2} - \text{Elev. 3}|}{\text{Setback Length}} \leq \text{Profile Grade of Adjacent Street}$$

$$\text{Ramp Cross Slope } u_3 = \frac{|\text{Elev. 4} - \text{Elev. 5}|}{\text{Ramp Width}} \leq 2.00\% \text{ (4)}$$

$$\text{Setback Cross Slope } u_4 = \frac{|\text{Elev. 6} - \text{Elev. 7}|}{\text{Ramp Width}} \leq 2.00\% \text{ (4)}$$

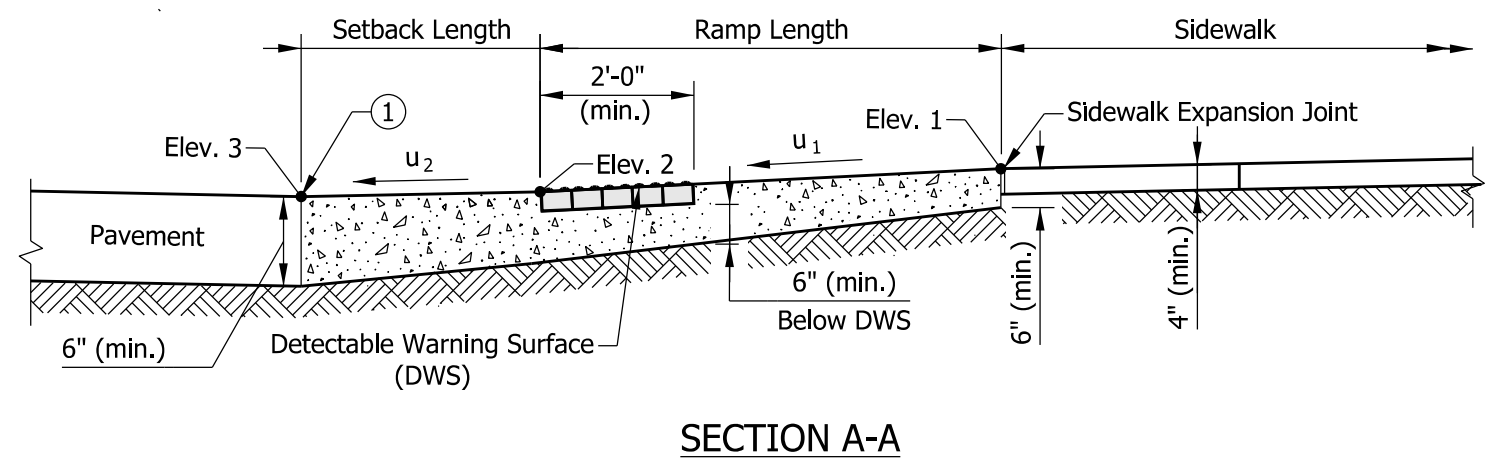
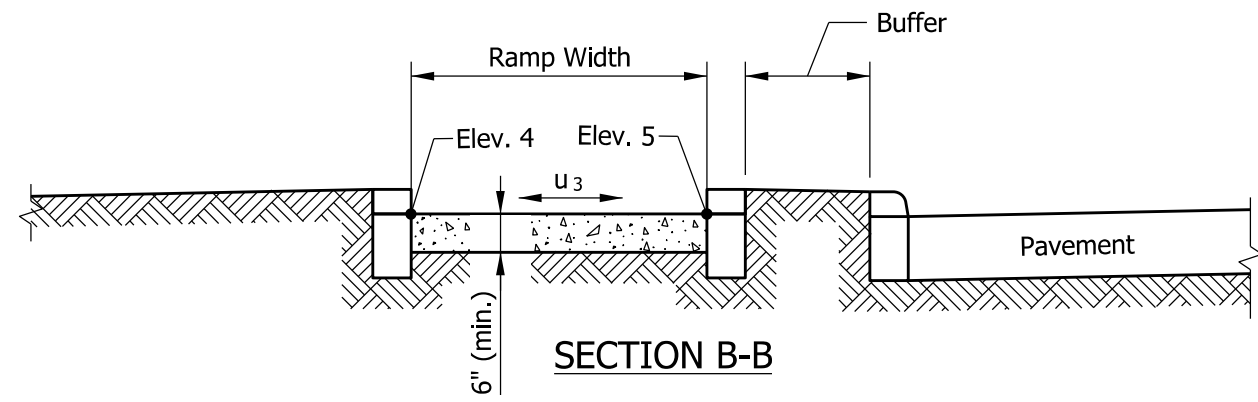

NOTES:

- ① The bottom edge of the ramp or setback and top of curb shall be flush with the edge of adjacent pavement and gutter line.
- ② A turning space is not required at the top of the ramp for a one-way directional perpendicular curb ramp.
- ③ Curb ramp surface shall be coarse broomed transverse to the running slope.
- ④ See Standard Drawing E 604-SWCR-01 for cross slope exceptions.
5. See Standard Drawing E 604-SWCR-12, -13, and -14 for Detectable Warning Surface placement, configuration, and details.
6. See Standard Drawing E 604-CCSJ-01 for sidewalk expansion joint details.

LEGEND:

- Buffer or Other Non-Walkable Surface
- Ramp
- Detectable Warning Surface

INDIANA DEPARTMENT OF TRANSPORTATION											
ONE-WAY DIRECTIONAL PERPENDICULAR CURB RAMP COMPONENT DETAILS											
SEPTEMBER 2018											
STANDARD DRAWING NO. E 604-SWCR-06											
	<table style="width: 100%; border: none;"> <tr> <td style="border: none;">/s/ Elizabeth W. Phillips</td> <td style="border: none; text-align: right;">03/29/18</td> </tr> <tr> <td style="border: none;">DESIGN STANDARDS ENGINEER</td> <td style="border: none; text-align: right;">DATE</td> </tr> <tr> <td colspan="2" style="border: none;"> </td> </tr> <tr> <td style="border: none;">/s/ John Leckie</td> <td style="border: none; text-align: right;">04/25/18</td> </tr> <tr> <td style="border: none;">CHIEF ENGINEER</td> <td style="border: none; text-align: right;">DATE</td> </tr> </table>	/s/ Elizabeth W. Phillips	03/29/18	DESIGN STANDARDS ENGINEER	DATE			/s/ John Leckie	04/25/18	CHIEF ENGINEER	DATE
/s/ Elizabeth W. Phillips	03/29/18										
DESIGN STANDARDS ENGINEER	DATE										
/s/ John Leckie	04/25/18										
CHIEF ENGINEER	DATE										

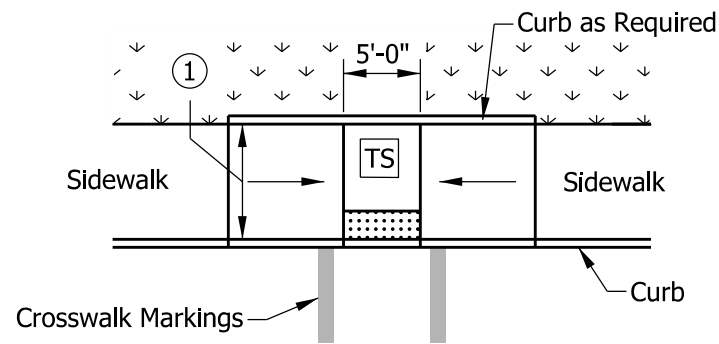

MIDBLOCK CROSSING CURB RAMP

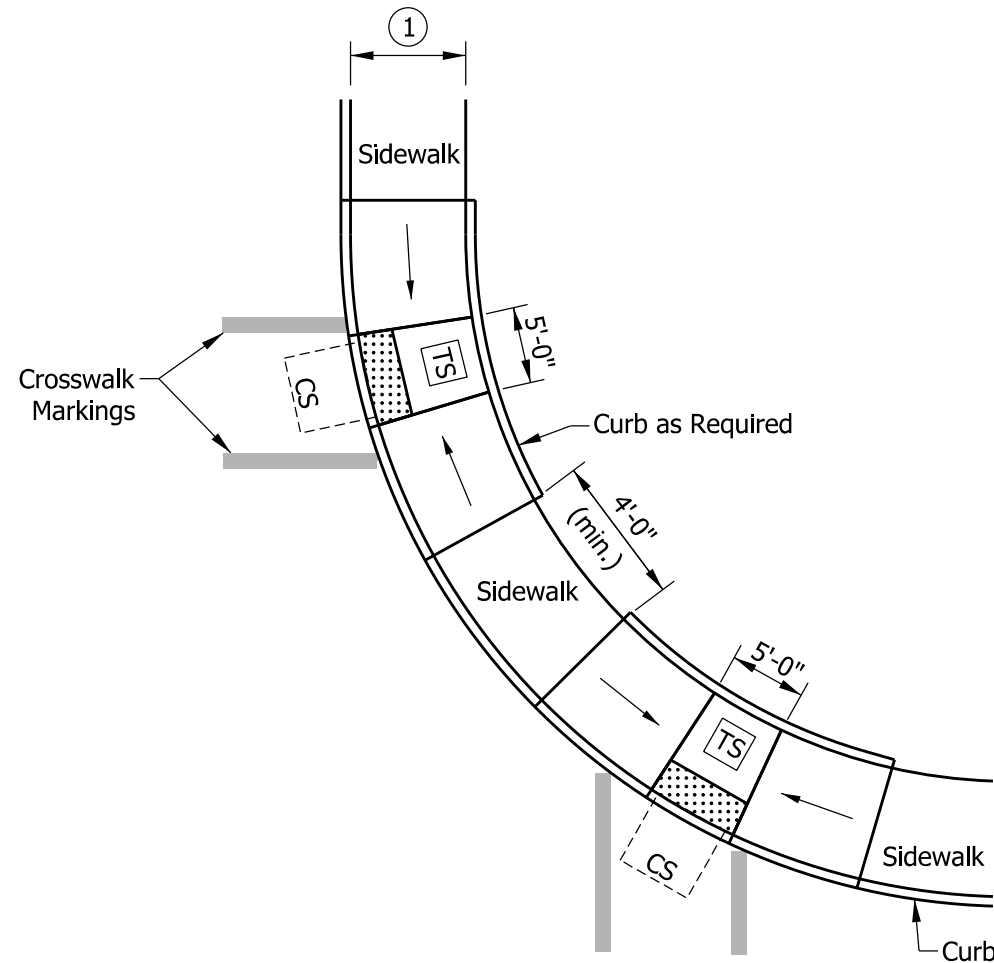





PAIRED PARALLEL CURB RAMPS ALONG LARGE RADIUS

NOTES:

- ① Where there is no buffer between the sidewalk and curb the preferred minimum sidewalk width is 6 ft. Where a buffer is placed between the sidewalk and curb, the preferred minimum sidewalk width is 5 ft. See Standard Drawing Series E 604-SDWK for sidewalk details.
2. The turning space shall have a minimum clear dimension of 4 ft x 4 ft and a running slope of 2.00% maximum. Where the turning space is constrained at the back of the sidewalk, the minimum clear dimension shall be 4 ft x 5 ft, with the 5-ft dimension in the direction of the ramp running slope.

LEGEND:

-  Buffer or Other Non-Walkable Surface
-  Ramp
-  Detectable Warning Surface
-  Turning Space
-  Clear Space

INDIANA DEPARTMENT OF TRANSPORTATION

PAIRED PARALLEL CURB RAMPS AND
MIDBLOCK CROSSING CURB RAMP
TYPICAL PLACEMENT

SEPTEMBER 2016

STANDARD DRAWING NO. E 604-SWCR-07

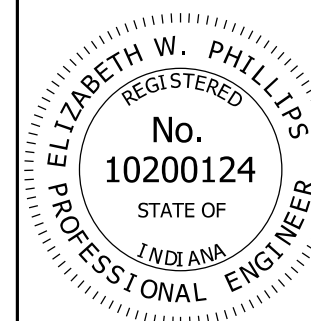

/s/ Elizabeth W. Phillips 03/15/16
DESIGN STANDARDS ENGINEER DATE

/s/ Mark A. Miller 03/18/16
CHIEF ENGINEER DATE

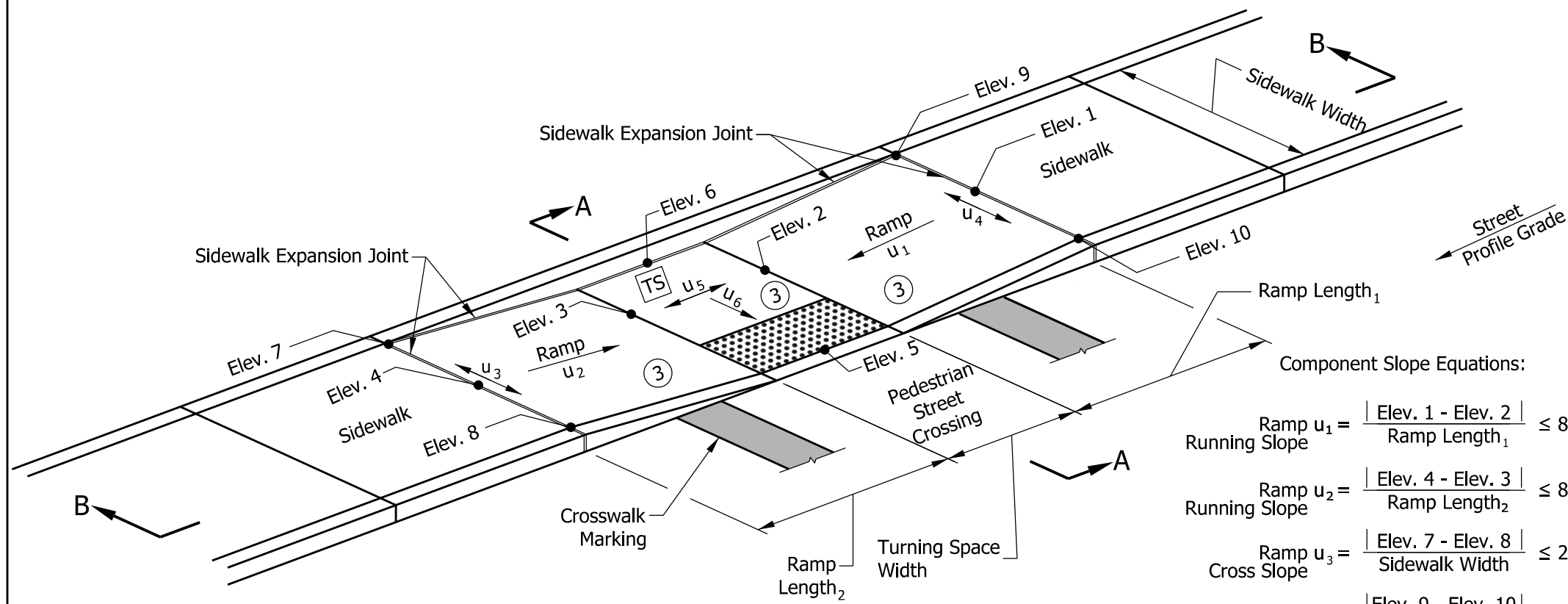

Component Slope Equations:

$$\text{Running Slope Ramp } u_1 = \frac{|\text{Elev. 1} - \text{Elev. 2}|}{\text{Ramp Length}_1} \leq 8.33\%$$

$$\text{Running Slope Ramp } u_2 = \frac{|\text{Elev. 4} - \text{Elev. 3}|}{\text{Ramp Length}_2} \leq 8.33\%$$

$$\text{Cross Slope Ramp } u_3 = \frac{|\text{Elev. 7} - \text{Elev. 8}|}{\text{Sidewalk Width}} \leq 2.00\%$$

$$\text{Cross Slope Ramp } u_4 = \frac{|\text{Elev. 9} - \text{Elev. 10}|}{\text{Sidewalk Width}} \leq 2.00\%$$

$$\text{Turning Space Cross Slope } u_5 = \frac{|\text{Elev. 2} - \text{Elev. 3}|}{\text{Turning Space Width}} \leq 2.00\% \text{ (5)}$$

$$\text{Turning Space Running Slope } u_6 = \frac{|\text{Elev. 6} - \text{Elev. 5}|}{\text{Sidewalk Width}} \leq 2.00\%$$

NOTES:

- ① The bottom edge of the turning space and top of curb shall be flush with the edge of adjacent pavement and gutter line.
- ② The turning space shall have a minimum clear dimension of 4 ft x 4 ft and a running slope of 2.00% maximum. Where the turning space is constrained at the back of the sidewalk, the minimum clear dimension shall be 4 ft x 5 ft, with the 5-ft dimension in the direction of the ramp running slope.
- ③ Curb ramp surface shall be coarse broomed transverse to the running slope.
- ④ Where there is no buffer between the sidewalk and curb, the preferred minimum sidewalk width is 6 ft. Where a buffer is placed between the sidewalk and curb, the preferred minimum sidewalk width is 5 ft. See Standard Drawing Series E 604-SDWK for sidewalk details.
- ⑤ See Standard Drawing E 604-SWCR-01 for cross slope exceptions.
6. See Standard Drawing E 604-SWCR-12, -13, and -14 for Detectable Warning Surface placement, configuration, and details.
7. See Standard Drawing E 604-CCSJ-01 for sidewalk expansion joint details.

LEGEND:

- Ramp
- Detectable Warning Surface
- Turning Space

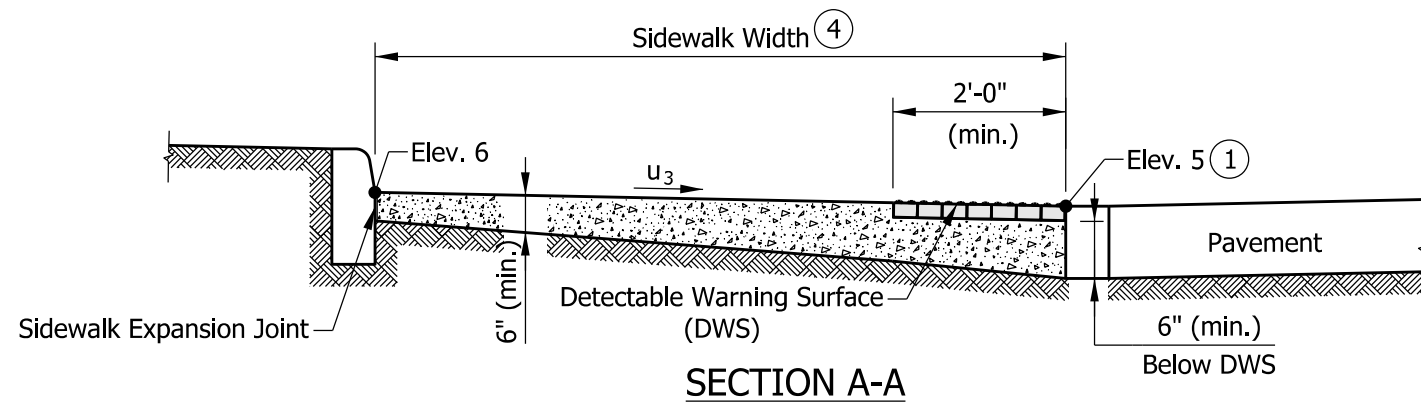
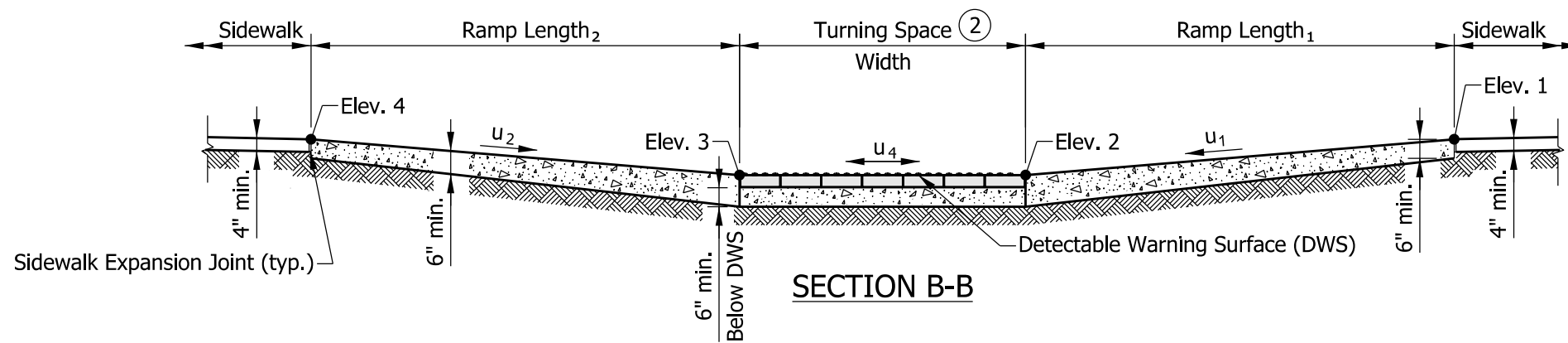

INDIANA DEPARTMENT OF TRANSPORTATION									
PARALLEL CURB RAMP COMPONENT DETAILS									
SEPTEMBER 2018									
STANDARD DRAWING NO. E 604-SWCR-08									
	<table style="width: 100%; border-collapse: collapse;"> <tr> <td style="text-align: center;"><i>/s/ Elizabeth W. Phillips</i></td> <td style="text-align: center;">03/29/18</td> </tr> <tr> <td style="text-align: center;">DESIGN STANDARDS ENGINEER</td> <td style="text-align: center;">DATE</td> </tr> <tr> <td style="text-align: center;"><i>/s/ John Leckie</i></td> <td style="text-align: center;">04/25/18</td> </tr> <tr> <td style="text-align: center;">CHIEF ENGINEER</td> <td style="text-align: center;">DATE</td> </tr> </table>	<i>/s/ Elizabeth W. Phillips</i>	03/29/18	DESIGN STANDARDS ENGINEER	DATE	<i>/s/ John Leckie</i>	04/25/18	CHIEF ENGINEER	DATE
<i>/s/ Elizabeth W. Phillips</i>	03/29/18								
DESIGN STANDARDS ENGINEER	DATE								
<i>/s/ John Leckie</i>	04/25/18								
CHIEF ENGINEER	DATE								

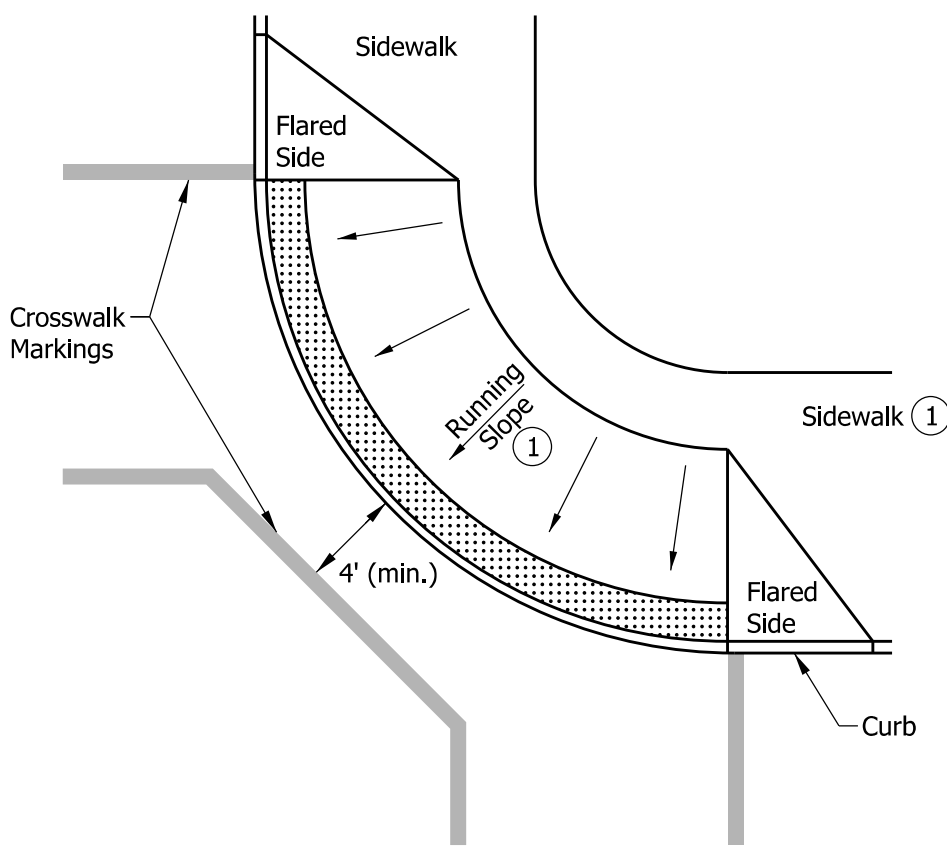

**BLENDING TRANSITION CURB RAMP
WITH RUNNING SLOPE > 2.00%**

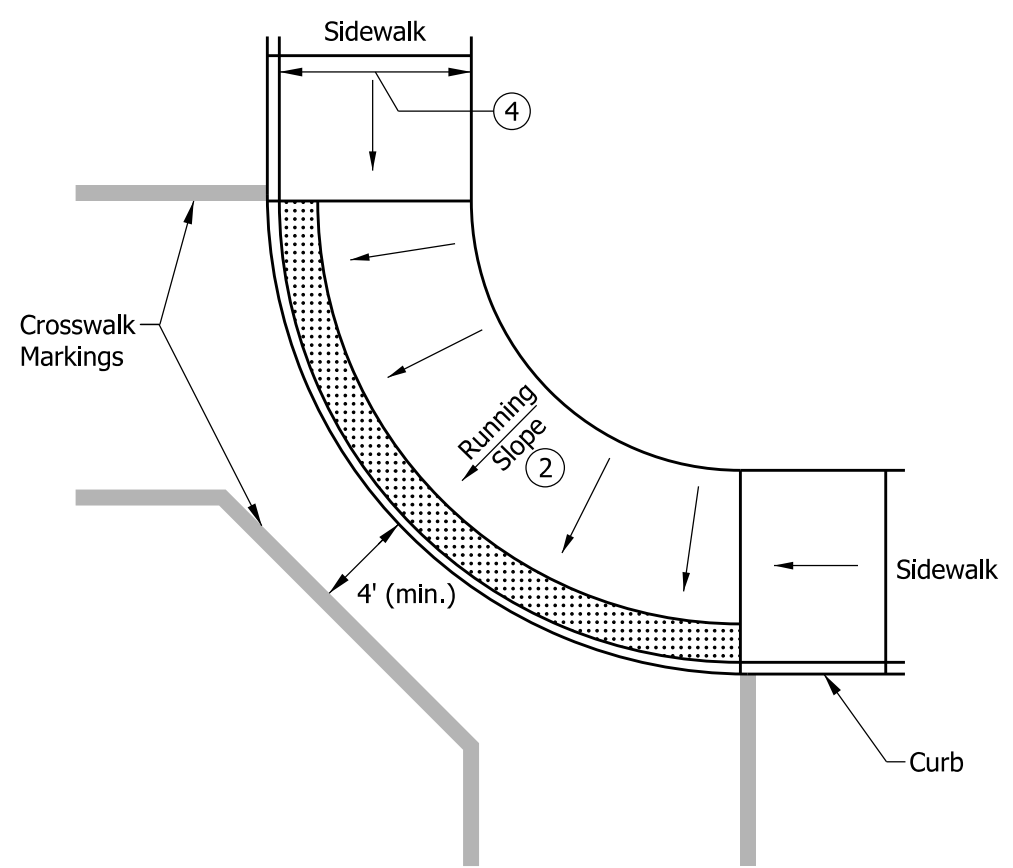

**BLENDING TRANSITION CURB RAMP
WITH RUNNING SLOPE ≤ 2.00%**

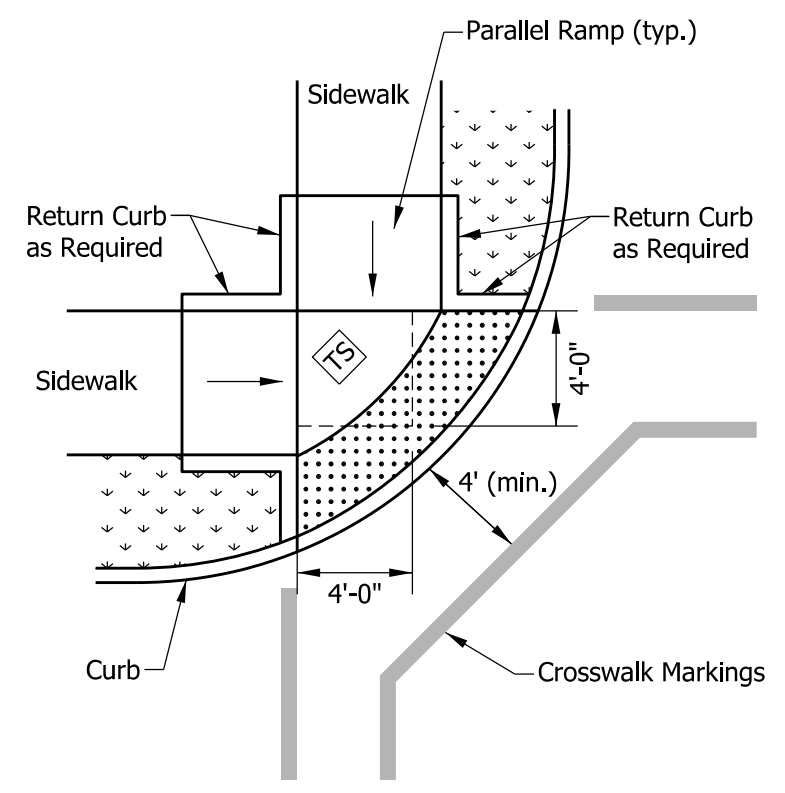

DEPRESSED CORNER CURB RAMP

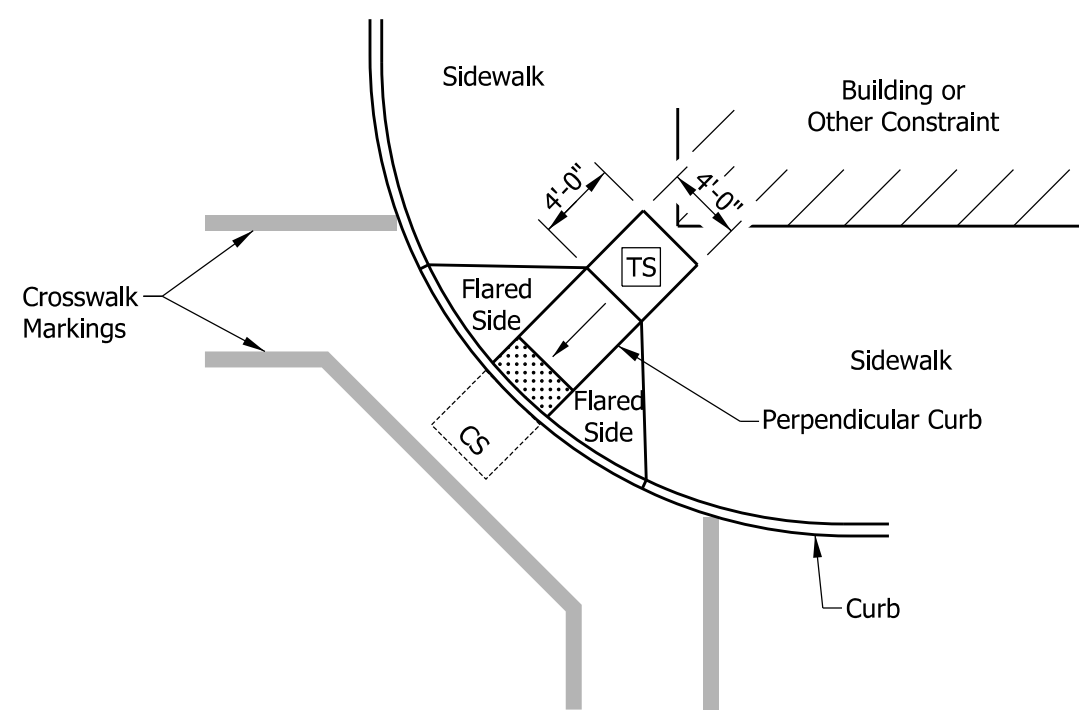

DIAGONAL CURB RAMP ③

NOTES:

- ① Where the running slope is greater than 2.00%, a 4-ft minimum sidewalk shall continue behind the blended transition. The running slope shall not exceed 5.00%.
- ② Where the running slope is less than or equal to 2.00% a 4-ft minimum sidewalk is not required behind the blended transition.
- ③ A diagonal curb ramp shall not be used for new construction. For an alteration project, a diagonal curb ramp shall be used only where existing physical conditions prevent paired curb ramps, a blended transition curb ramp, or a depressed corner curb ramp from being provided.
- ④ Where there is no buffer between the sidewalk and curb the preferred minimum sidewalk width is 6 ft. Where a buffer is placed between the sidewalk and curb, the preferred minimum sidewalk width is 5 ft. See Standard Drawing Series E 604-SDWK for sidewalk details.

LEGEND:

- Buffer or Other Non-Walkable Surface
- Ramp
- Detectable Warning Surface
- Turning Space
- Clear Space

INDIANA DEPARTMENT OF TRANSPORTATION											
BLENDING TRANSITION CURB RAMP, DEPRESSED CURB RAMP AND DIAGONAL CURB RAMP TYPICAL PLACEMENT											
SEPTEMBER 2018											
STANDARD DRAWING NO. E 604-SWCR-09											
	<table style="width: 100%; border: none;"> <tr> <td style="border: none;">/s/ Elizabeth W. Phillips</td> <td style="border: none; text-align: right;">03/29/18</td> </tr> <tr> <td style="border: none;">DESIGN STANDARDS ENGINEER</td> <td style="border: none; text-align: right;">DATE</td> </tr> <tr> <td colspan="2" style="border: none;"> </td> </tr> <tr> <td style="border: none;">/s/ John Leckie</td> <td style="border: none; text-align: right;">04/25/18</td> </tr> <tr> <td style="border: none;">CHIEF ENGINEER</td> <td style="border: none; text-align: right;">DATE</td> </tr> </table>	/s/ Elizabeth W. Phillips	03/29/18	DESIGN STANDARDS ENGINEER	DATE			/s/ John Leckie	04/25/18	CHIEF ENGINEER	DATE
/s/ Elizabeth W. Phillips	03/29/18										
DESIGN STANDARDS ENGINEER	DATE										
/s/ John Leckie	04/25/18										
CHIEF ENGINEER	DATE										

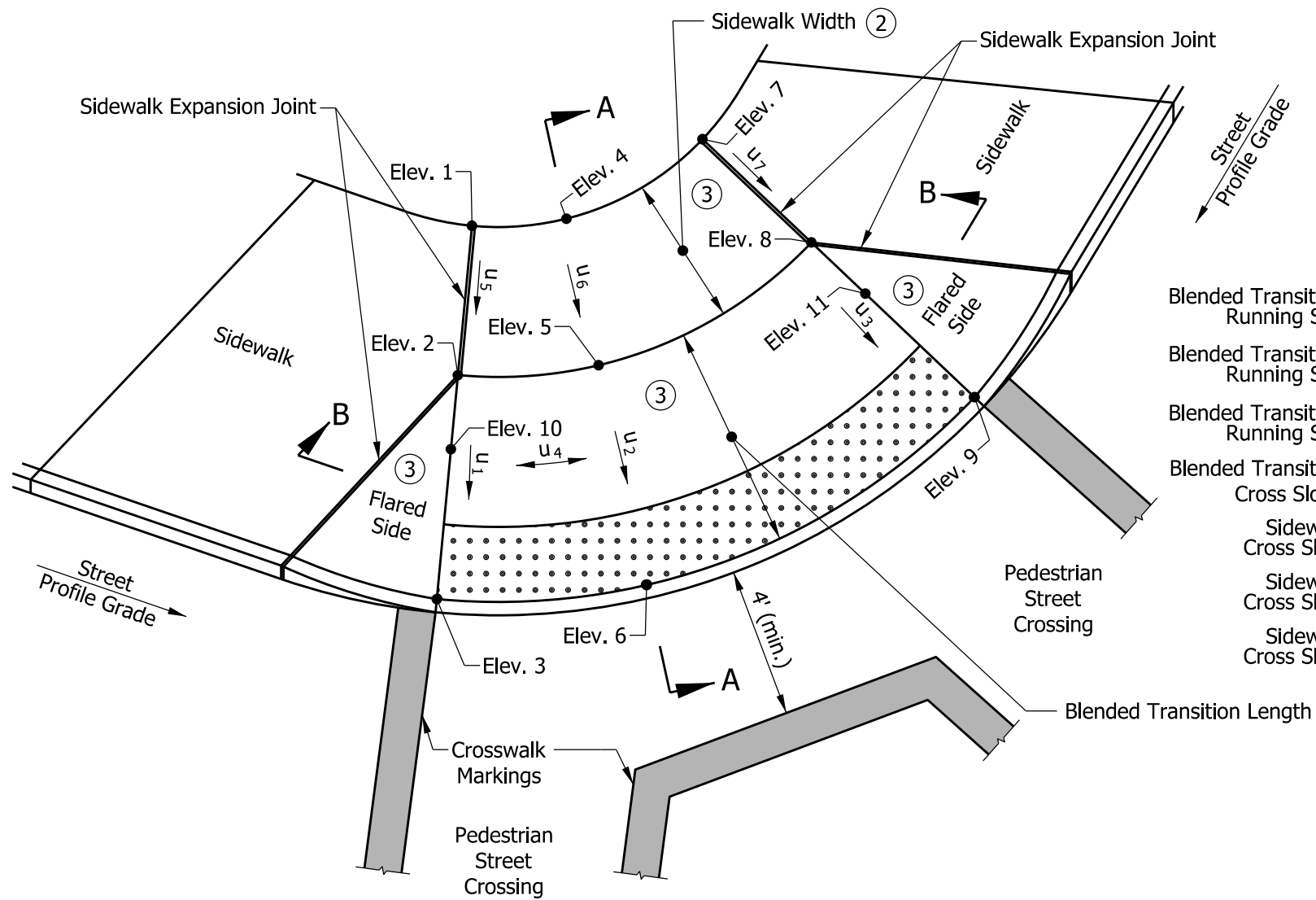

Component Slope Equations:

Blended Transition u_1 = Running Slope	$\frac{ \text{Elev. 2} - \text{Elev. 3} }{\text{Blended Transition Length}} \leq 2.00\%$ ②
Blended Transition u_2 = Running Slope	$\frac{ \text{Elev. 5} - \text{Elev. 6} }{\text{Blended Transition Length}} \leq 2.00\%$ ②
Blended Transition u_3 = Running Slope	$\frac{ \text{Elev. 8} - \text{Elev. 9} }{\text{Blended Transition Length}} \leq 2.00\%$ ②
Blended Transition u_4 = Cross Slope	$\frac{ \text{Elev. 10} - \text{Elev. 11} }{\text{Blended Transition Width}} \leq 2.00\%$ ④
Sidewalk u_5 = Cross Slope	$\frac{ \text{Elev. 1} - \text{Elev. 2} }{\text{Sidewalk Width}} \leq 2.00\%$
Sidewalk u_6 = Cross Slope	$\frac{ \text{Elev. 4} - \text{Elev. 5} }{\text{Sidewalk Width}} \leq 2.00\%$
Sidewalk u_7 = Cross Slope	$\frac{ \text{Elev. 7} - \text{Elev. 8} }{\text{Sidewalk Width}} \leq 2.00\%$

NOTES:

- ① The bottom edge of the blended transition and top of curb shall be flush with the edge of adjacent pavement and gutter line.
- ② Where the running slope is less than or equal to 2.00% a 4-ft minimum sidewalk is not required, behind the blended transition. Where the running slope is greater than 2.00%, a 4-ft minimum sidewalk shall continue behind the blended transition and the running slope shall not exceed 5.00%.
- ③ Curb ramp surface shall be coarse broomed transverse to the running slope.
- ④ See Standard Drawing E 604-SWCR-01 for cross slope exceptions.
5. See Standard Drawing E 604-SWCR-12, -13, and -14 for Detectable Warning Surface placement, configuration, and details.
6. See Standard Drawing E 604-CCSJ-01 for sidewalk expansion joint details.

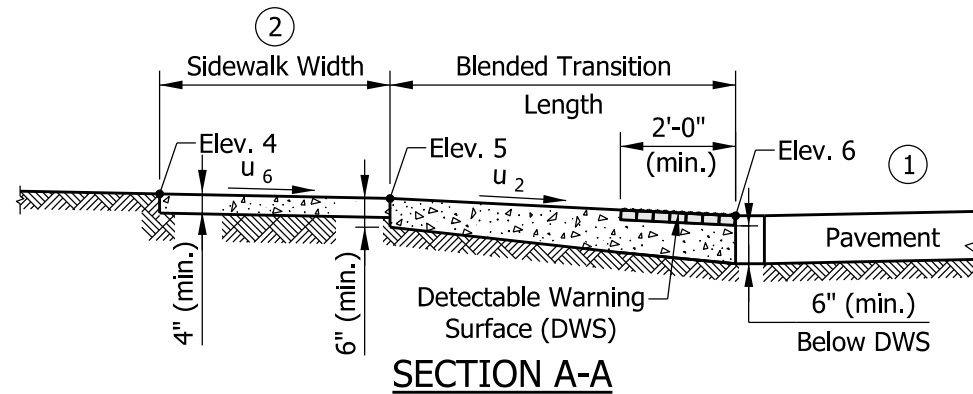
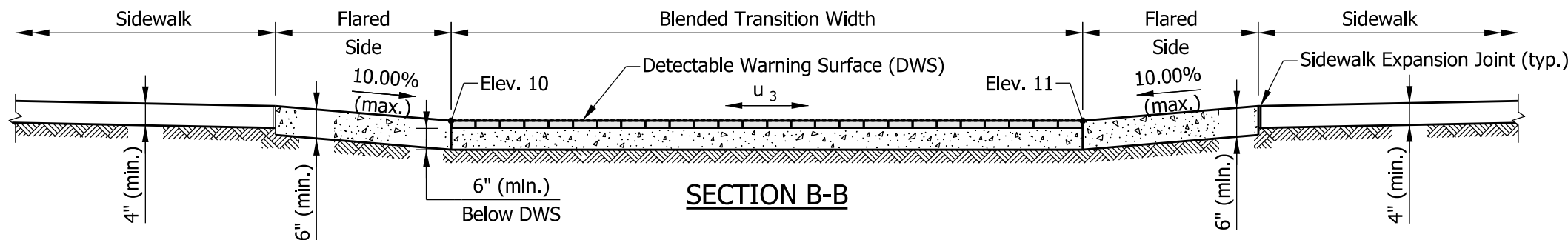

LEGEND:

- Ramp
- Detectable Warning Surface

INDIANA DEPARTMENT OF TRANSPORTATION

BLENDED TRANSITION CURB RAMP
COMPONENT DETAILS

SEPTEMBER 2018

STANDARD DRAWING NO. E 604-SWCR-10

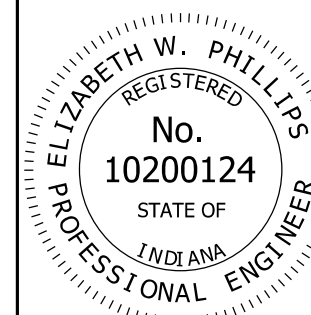

/s/ Elizabeth W. Phillips 03/29/18
DESIGN STANDARDS ENGINEER DATE

/s/ John Leckie 04/25/18
CHIEF ENGINEER DATE

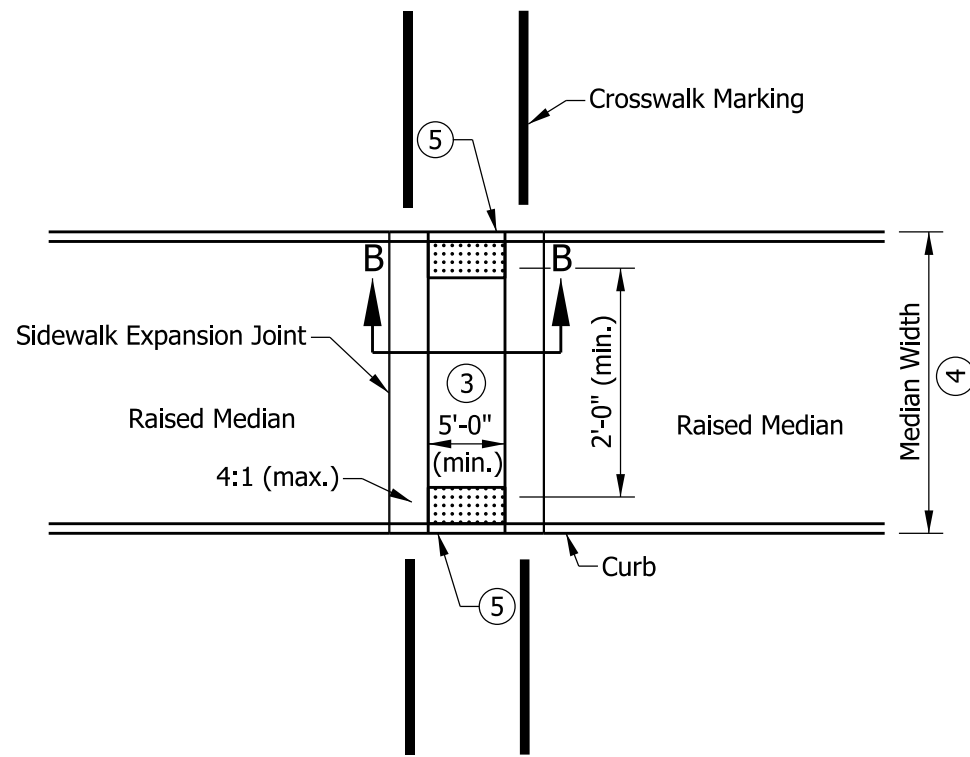

MEDIAN CUT-THROUGH WITH TAPERED CURB

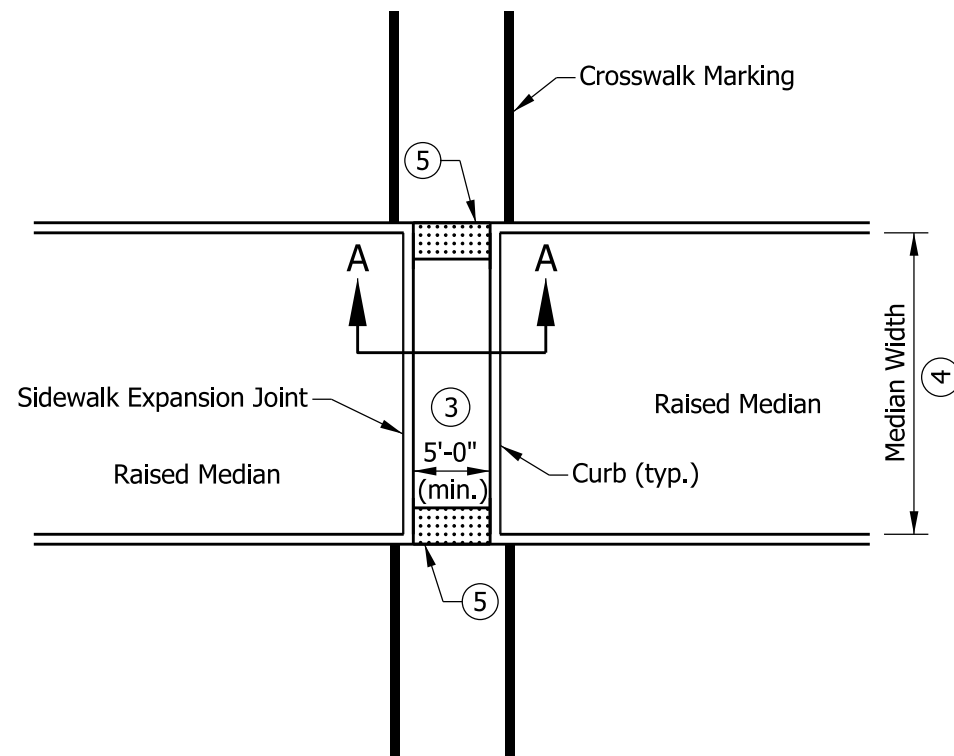
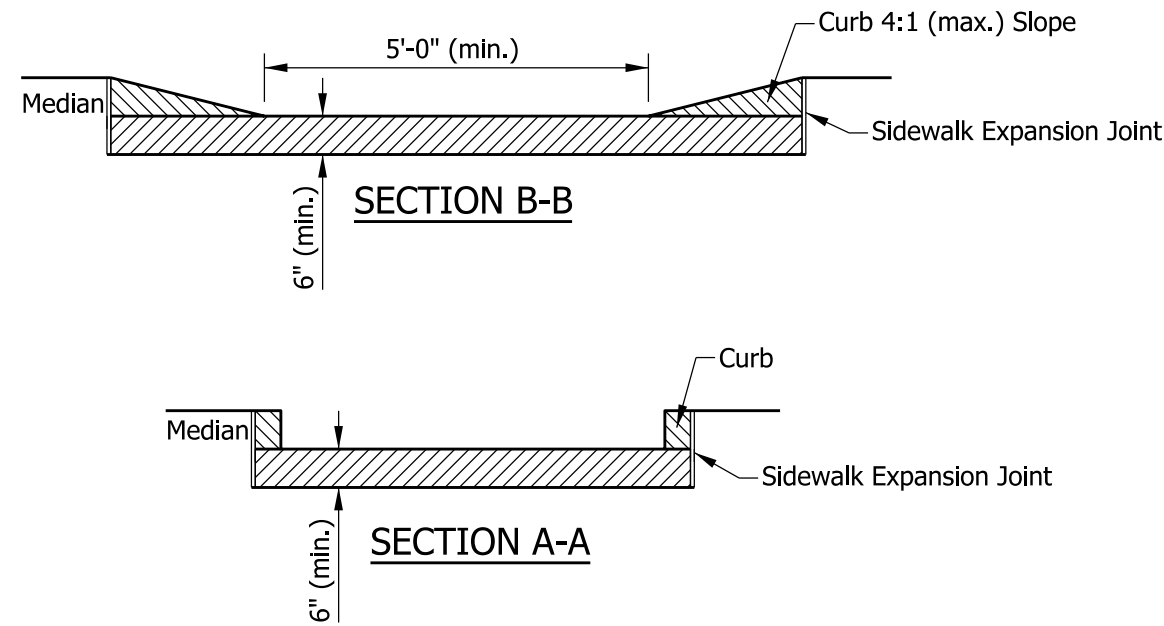

MEDIAN CUT-THROUGH WITH CURB

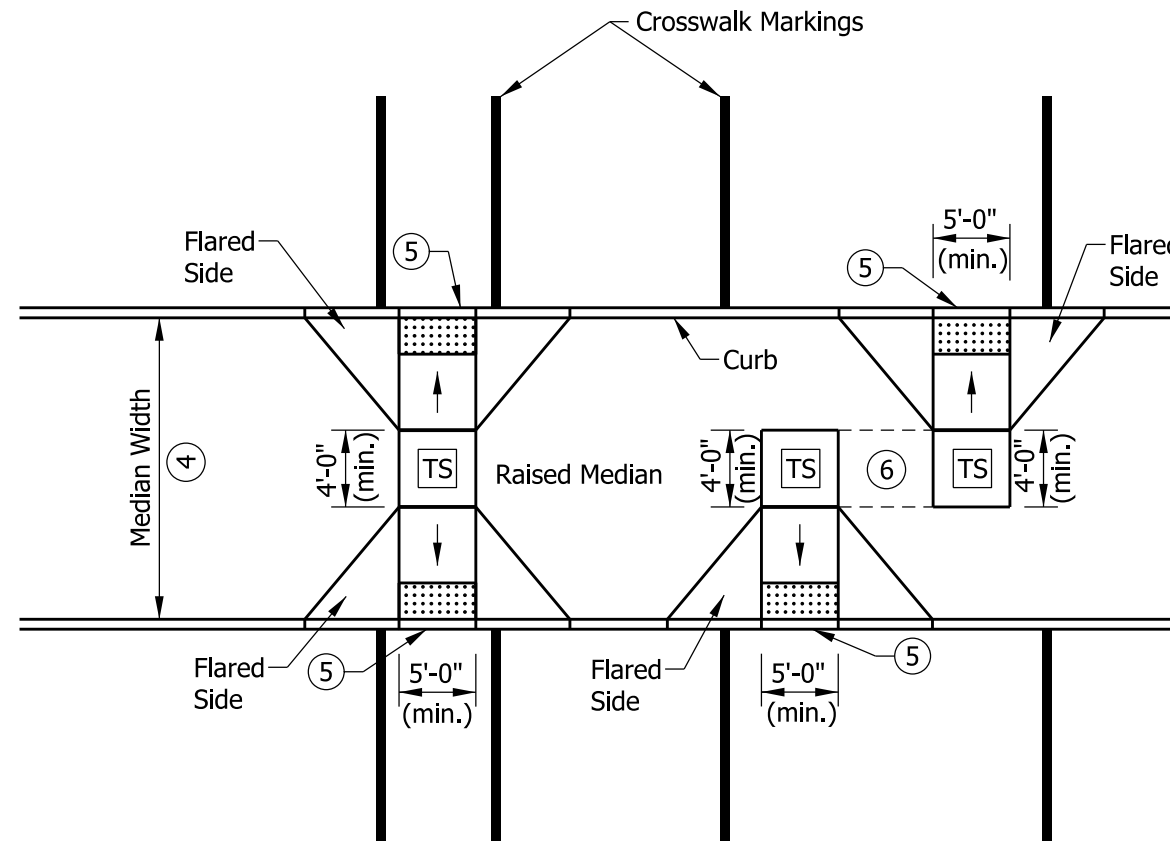

MEDIAN PERPENDICULAR CURB RAMPS

NOTES:

1. The minimum width of a median cut-through and median perpendicular curb ramp shall be 5 ft.
2. Where in-line or offset perpendicular curb ramps are used within a median, the turning space shall have a minimum clear dimension of 4 ft x 5 ft.
3. Where a median cut through is used the running slope shall be 5.00% maximum.
4. Where median width is less than 6 ft, detectable warning surfaces shall not be placed.
5. The bottom edge of the median cut-through or median perpendicular curb ramp and the top of curb shall be flush with the edge of adjacent pavement gutter line.
6. See Standard Drawing E 604-SWCR-01 for cross slope exceptions.
7. See Standard Drawing E 604-SWCR-12, -13, and -14 for Detectable Warning Surface placement, configuration, and details.
8. See Standard Drawing E 604-CCSJ-01 for sidewalk expansion joint details.

LEGEND:

- Ramp
- Detectable Warning Surface
- Turning Space

INDIANA DEPARTMENT OF TRANSPORTATION

MEDIAN CUT-THROUGH AND
MEDIAN PERPENDICULAR CURB RAMP
TYPICAL PLACEMENT

SEPTEMBER 2023

STANDARD DRAWING NO. E 604-SWCR-11

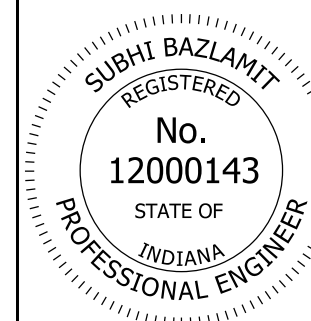

Subhi Bazlamit 04/28/2023
DESIGN STANDARDS ENGINEER DATE

[Signature] 05/12/2023
CHIEF ENGINEER DATE

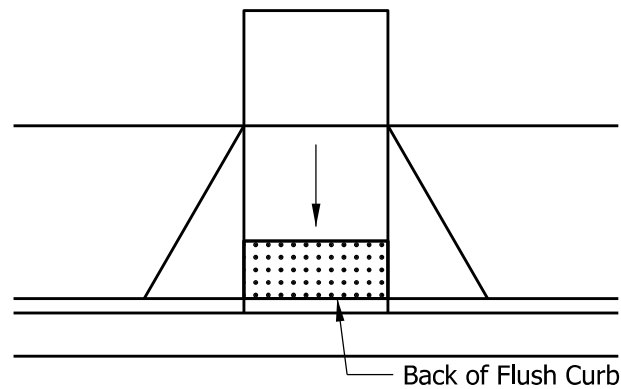

PERPENDICULAR CURB RAMP

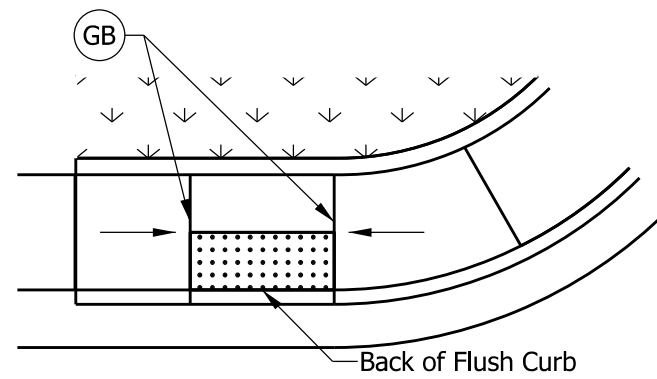

PARALLEL CURB RAMP ④

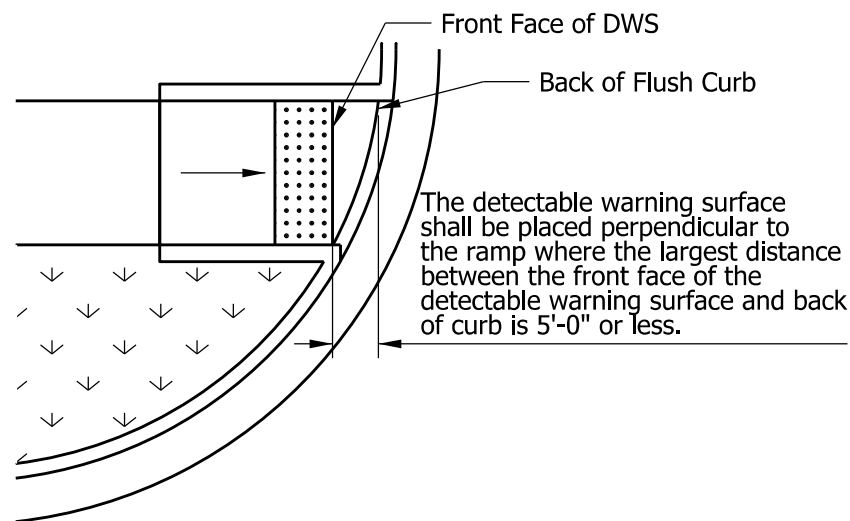

ONE-WAY DIRECTIONAL PERPENDICULAR CURB RAMPS ON A RADIUS ③

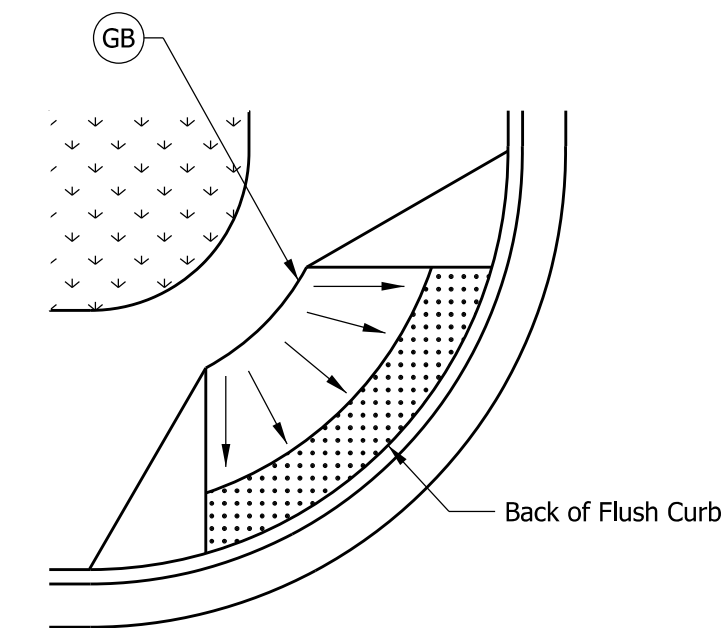
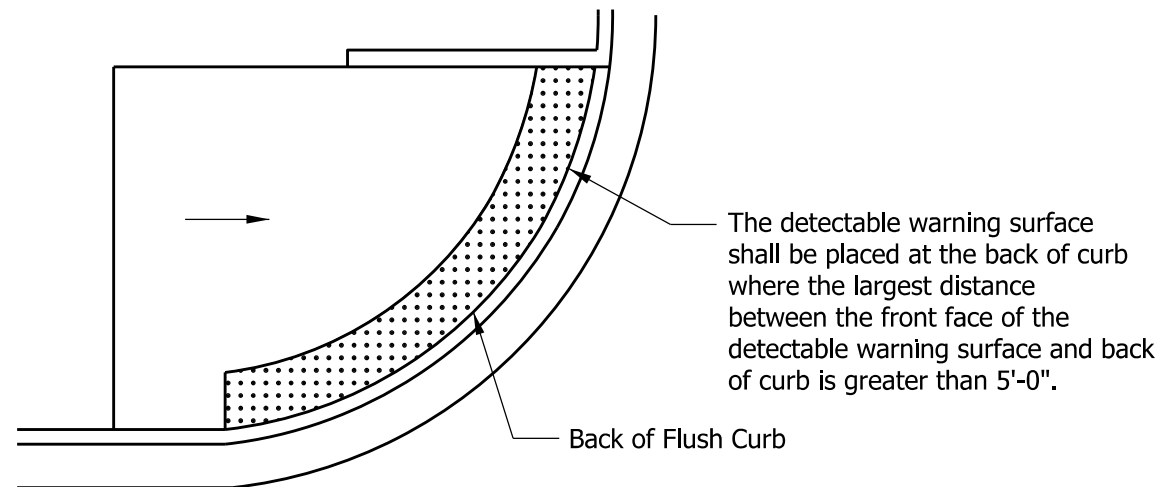

BLENDED TRANSITION CURB RAMP ⑤

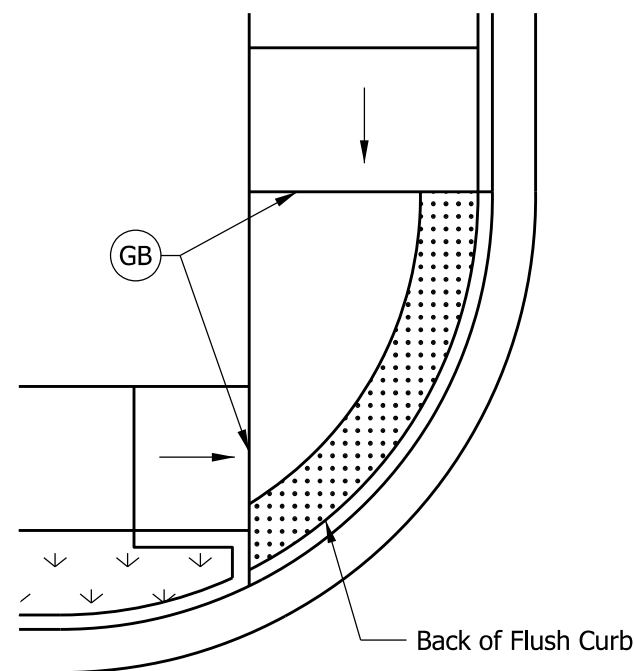

DEPRESSED CORNER CURB RAMP ⑤ ⑦

LEGEND:

- Buffer or Other Non-Walkable Surface
- Detectable Warning Surface (DWS)
- Ramp
- Grade Break

NOTES:

1. A detectable warning surface shall be placed at each street, highway, or railroad crossing. See Standard Drawing E 604-SDWK-03 for a detectable warning surface placement at a sidewalk driveway crossing.
2. The detectable warning surface shall extend a minimum of 2 ft in the direction of pedestrian travel and extend the full width as shown. The detectable warning surface shall not be placed across a grade break.
- ③ Where the distance from the face of the detectable warning surface is 5 ft or less from the back of curb, the detectable warning surface shall be placed perpendicular to the ramp. Where the distance from the face of the detectable warning surface is more than 5 ft from the back of curb, the detectable warning surface shall be placed at the back of curb as shown or in an alternate placement configuration. See Standard Drawing E 604-SWCR-13 for alternate detectable warning surface placement.
- ④ The detectable warning surface on a parallel curb ramp shall be placed on the turning space at the flush transition between the street and turning space at the back of curb.
- ⑤ The detectable warning surface on a blended transition or depressed corner shall be placed at the back of curb as shown or in an alternate placement configuration. See Standard Drawing E 604-SWCR-13 for alternate detectable warning surface placement.
6. See Standard Drawing E 604-SWCR-14 for detectable warning surface details.

INDIANA DEPARTMENT OF TRANSPORTATION

DETECTABLE WARNING SURFACE
PLACEMENT AND CONFIGURATION

SEPTEMBER 2018

STANDARD DRAWING NO. E 604-SWCR-12

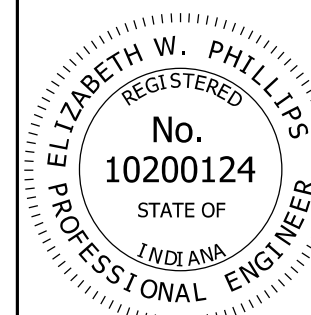

/s/ Elizabeth W. Phillips 03/29/18
DESIGN STANDARDS ENGINEER DATE

/s/ John Leckie 04/25/18
CHIEF ENGINEER DATE

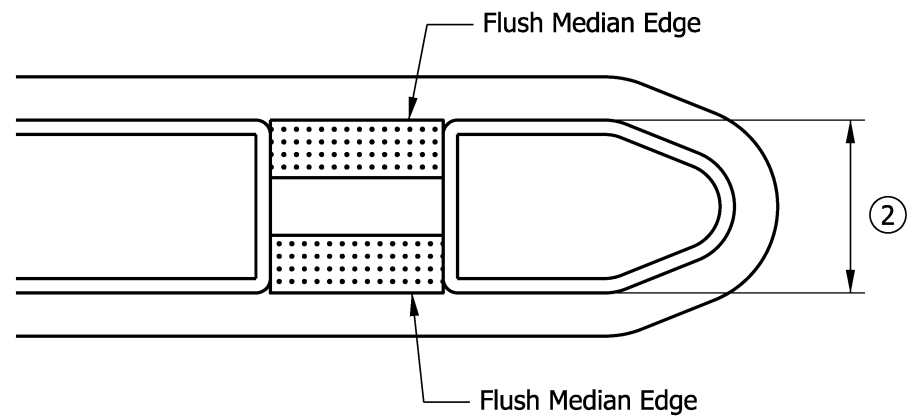

MEDIAN CUT-THROUGH

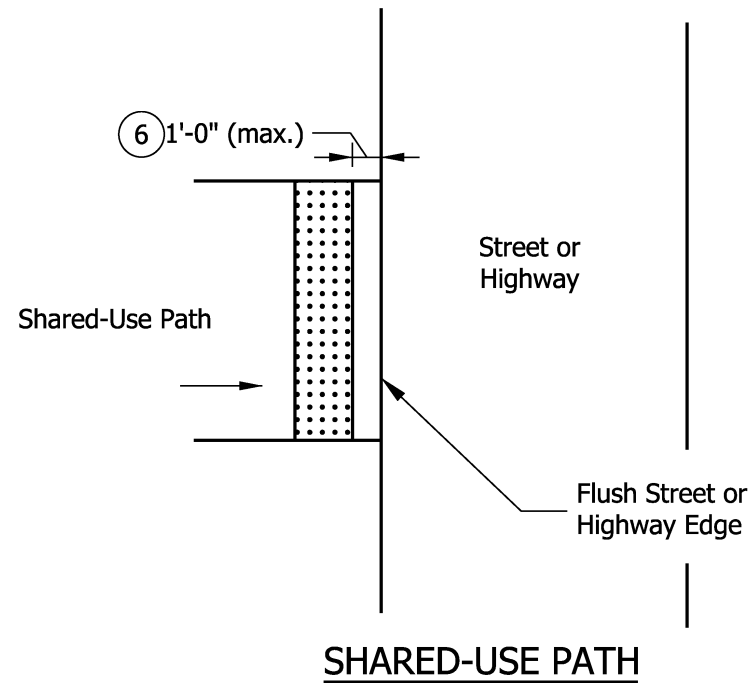

SHARED-USE PATH

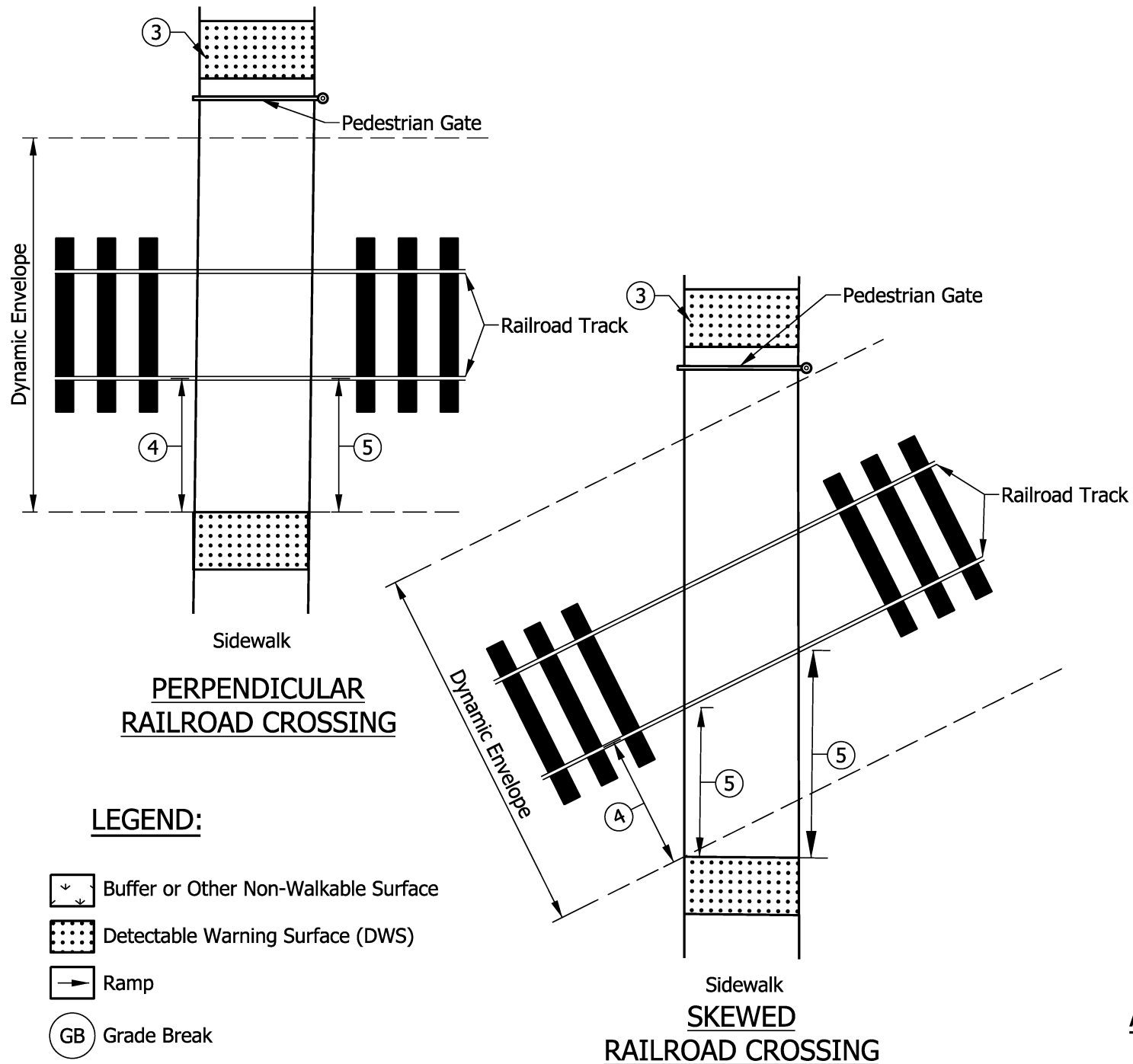

PERPENDICULAR RAILROAD CROSSING

SKEWED RAILROAD CROSSING

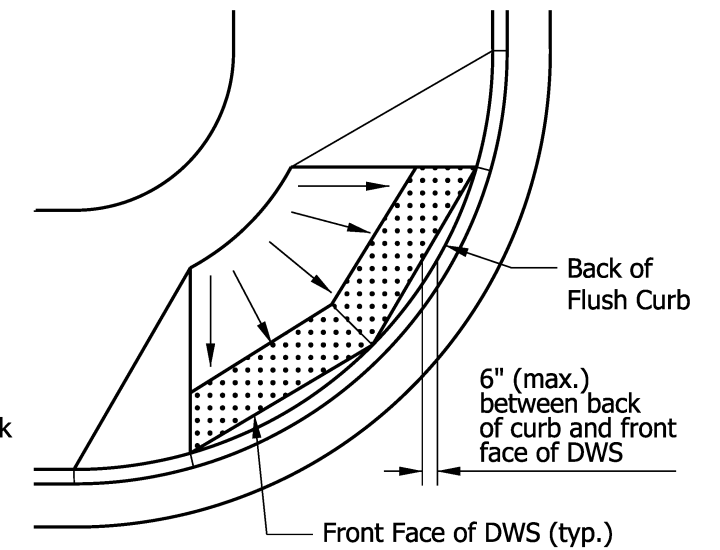

ALTERNATE DETECTABLE WARNING SURFACE PLACEMENT 7

NOTES:

1. The detectable warning surface shall extend a minimum length of 2 ft in the direction of pedestrian travel and extend the full width as shown. The detectable warning surface shall not be placed across a grade break. The edges of adjacent panels shall be parallel and tightly abutted.
2. The detectable warning surface on a median cut-through shall be placed at the flush transition between the street and median cut-through. Where a median is less than 6 ft, a detectable warning surface shall not be placed.
3. Where a pedestrian gate is provided at a railroad crossing, the detectable warning surface shall be placed on the side of the gate opposite the railroad crossing.
4. The detectable warning surface shall be outside of the railroad dynamic envelope, 6 ft min. from the centerline of the nearest rail.
5. The edge of the detectable warning surface shall not be within the dynamic envelope and no greater than 15 ft from the centerline of the nearest rail.
6. Where shared-use path intersects a street or highway, the detectable warning surface shall be placed on the shared-use path within 1 ft of the street or highway edge.
7. DWS panel ends shall be placed at the back of curb. The distance between the back of curb and the front face of the detectable warning surface shall not exceed 6 in. between the ends.
8. See Standard Drawing E 604-SWCR-14 for detectable warning surface details.

LEGEND:

- Buffer or Other Non-Walkable Surface
- Detectable Warning Surface (DWS)
- Ramp
- Grade Break

INDIANA DEPARTMENT OF TRANSPORTATION

DETECTABLE WARNING SURFACE
PLACEMENT AND CONFIGURATION

SEPTEMBER 2023

STANDARD DRAWING NO. E 604-SWCR-13

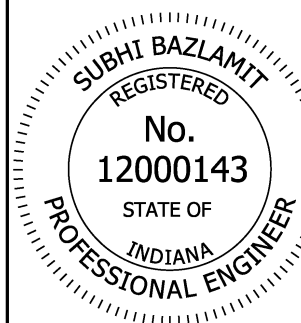

Subhi Bazlamit 04/28/2023
DESIGN STANDARDS ENGINEER DATE

[Signature] 05/08/2023
CHIEF ENGINEER DATE

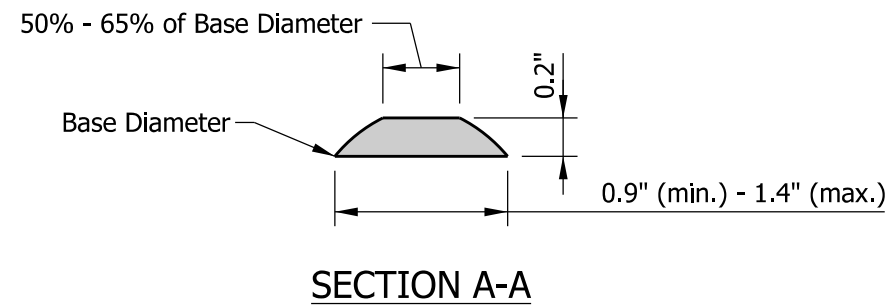
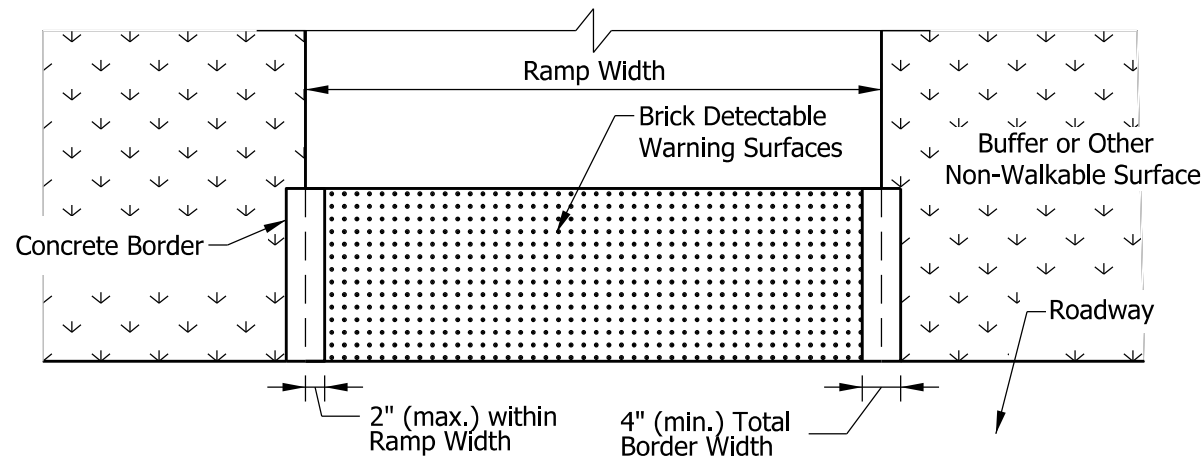

BRICK DETECTABLE WARNING SURFACE WITH CONCRETE BORDER ⑥ ⑦

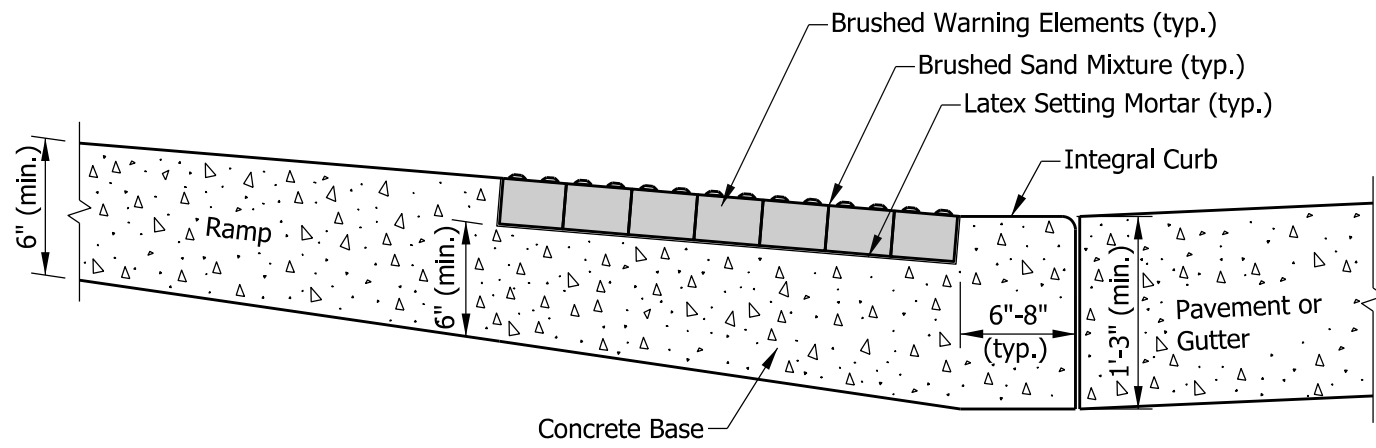

TYPICAL RAMP AND BRICK SURFACE CONSTRUCTION DETAIL

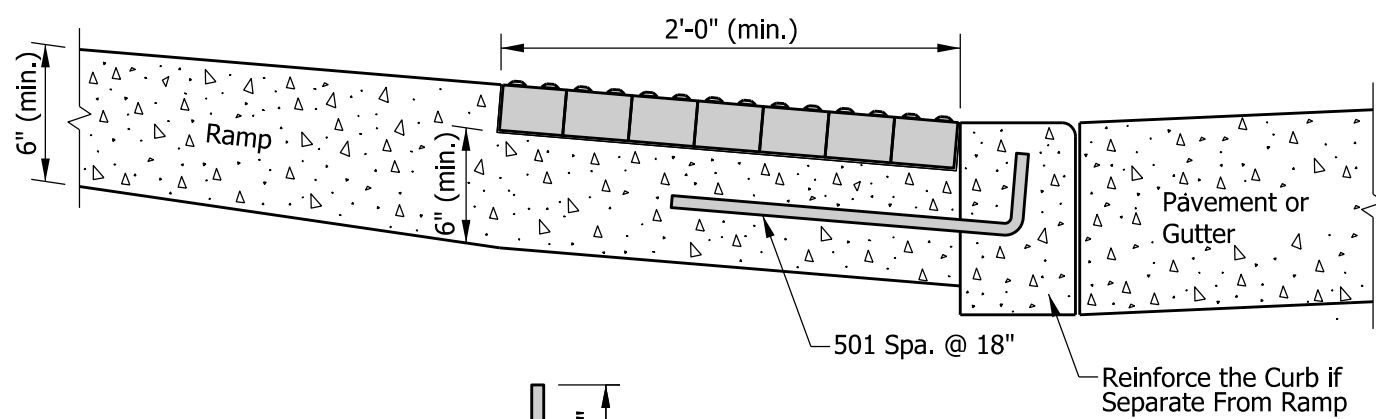

ALTERNATE CURB CONSTRUCTION

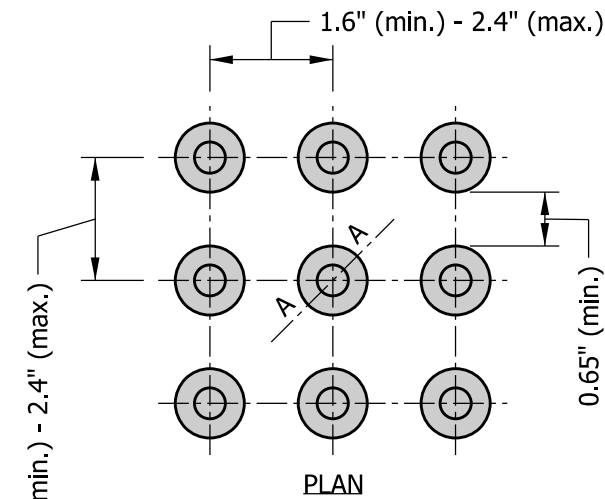
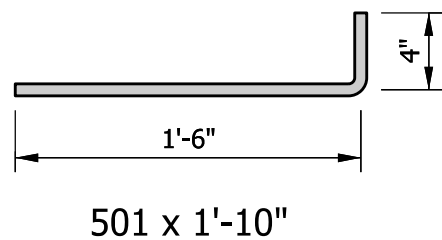

TRUNCATED DOMES

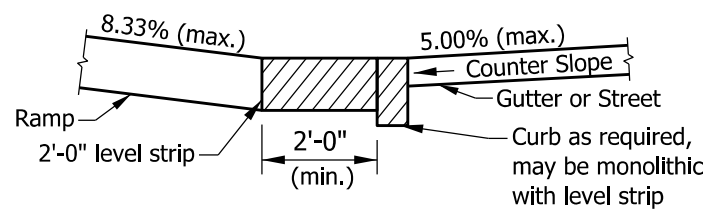

CHANGE OF GRADE > 11% ⑤

NOTES:

1. Detectable warning surface shall consist of truncated domes. Domes shall be aligned in a square or radial grid pattern with diameter and center-to-center spacing within the ranges specified.
2. The detectable warning surface may be field cut. Truncated dome spacing between adjacent panels shall be within the ranges specified.
3. The detectable warning surface shall contrast visually with adjacent surfaces, either light-on-dark or dark-on-light.
4. The detectable warning surface shall extend a minimum of 2 ft in the direction of pedestrian travel and extend the full width as shown. The detectable warning surface shall not be placed across a grade break.
- ⑤ The maximum counter slope of the gutter or street at the bottom of the ramp shall be 5.00%. Where the algebraic difference between the running slope and the counter slope exceeds 11%, a 2-ft minimum level strip should be provided at the bottom of the ramp.
- ⑥ Where a concrete border is used for forming, the border shall be cast monolithically with the curb ramp concrete. The concrete border shall not reduce the ramp width by more than 2 in. on each side.
- ⑦ Where forming other than a concrete border is used, the edge restraint shall not encroach upon the ramp width.

INDIANA DEPARTMENT OF TRANSPORTATION											
DETECTABLE WARNING SURFACE DETAILS											
SEPTEMBER 2018											
STANDARD DRAWING NO. E 604-SWCR-14											
	<table style="width: 100%; border: none;"> <tr> <td style="border: none;">/s/ <i>Elizabeth W. Phillips</i></td> <td style="border: none;">03/29/18</td> </tr> <tr> <td style="border: none;">DESIGN STANDARDS ENGINEER</td> <td style="border: none;">DATE</td> </tr> <tr> <td colspan="2" style="border: none;"> </td> </tr> <tr> <td style="border: none;">/s/ <i>John Leckie</i></td> <td style="border: none;">04/25/18</td> </tr> <tr> <td style="border: none;">CHIEF ENGINEER</td> <td style="border: none;">DATE</td> </tr> </table>	/s/ <i>Elizabeth W. Phillips</i>	03/29/18	DESIGN STANDARDS ENGINEER	DATE			/s/ <i>John Leckie</i>	04/25/18	CHIEF ENGINEER	DATE
/s/ <i>Elizabeth W. Phillips</i>	03/29/18										
DESIGN STANDARDS ENGINEER	DATE										
/s/ <i>John Leckie</i>	04/25/18										
CHIEF ENGINEER	DATE										